

Fire safety in purpose-built blocks of flats



Foreword

Flats have been used to house people since Victorian times. From the early tenements for the poor to mansion blocks for the affluent, these buildings were often seen as innovative solutions to the country's housing needs.

However, it was the post war demand for affordable housing that, in the 1940s and 50s, spurred on the building of high-density, purpose-built blocks of flats. In the 1960s, in particular, high-rise blocks began to dominate the skyline of towns and cities across the country. Each flat represented a self-contained, domestic dwelling, the block where it was located having all the necessary facilities and amenities each household needed to live independently of others.

Given that most fires occur in domestic dwellings, it was recognised that a block of flats – as a building containing many such dwellings – had the potential for a higher risk to people should fire break out. Accordingly, the fire safety standards that were developed to address this risk sought to afford the same level of safety found in houses to those living in blocks of flats.

These standards have been embodied in Building Regulations, which, now as then, ensure that adequate fire safety provisions are incorporated in blocks of flats when they are constructed.

The Regulatory Reform (Fire Safety) Order 2005 (the FSO) came into force in October 2006. It brought the common parts of blocks of flats within the scope of mainstream fire safety legislation for the first time.

Guidance on the FSO and its requirements has been issued in a series of guides. Blocks of flats are included, among many other types of residential premises, in the HM Government guide 'Fire safety risk assessment: sleeping accommodation' published by the Department for Communities and Local Government (DCLG).

However, application of the FSO to blocks of flats has proved problematic: it has led to widely varying outcomes. In some buildings, significant work to upgrade fire safety standards within the common parts has been undertaken to satisfy this legislation. In others, none has been considered necessary.

There has also been confusion over the scope of this legislation: how it relates to those who live in the flats, and, indeed, to what extent, if any, this legislation can require improvements beyond the flat entrance door. These are just two of the questions that tax those seeking to apply and enforce it.

Enforcing authorities are often unfamiliar with the particular issues that can be found in existing blocks of flats. In addition many of those now giving advice to landlords and managing agents also have limited experience of these issues. Of particular concern is the resulting variation in the findings of fire risk assessments carried out by third parties on behalf of landlords and others responsible for fire safety in blocks of flats.

This guide is intended to meet the needs of housing providers and enforcing authorities for guidance tailored to purpose-built blocks of flats. These buildings are only a small part of the scope of other guidance documents. This document is intended to assist responsible persons to comply with the FSO and the Housing Act 2004. Accordingly, it is expected that enforcing authorities will have regard to this guide.

Contents

Acknowledgments	9
Introduction	11
1. Responsibility for this guide	11
2. Purpose	11
3. Scope of this guidance	12
4. Intended readership	13
5. Relationship to other guidance	14
6. Layout of the guide	14
7. Appendices	17
8. Glossary	17
9. Bibliography	17
Part A: Safe as Houses? Fires in flats and their impact	18
10. Fires in domestic dwellings	19
11. Relative risk in flats	19
12. Is 'stay put' safe?	20
13. High-rise equals high-risk?	20
14. Factors influencing the likelihood of a fire	21
Part B: Fire safety – how blocks of flats differ from other residences	22
15. Introduction	23
16. Means of escape	23
17. Compartmentation	26

18. Evacuation strategy	27
19. 'Stay put' policy	27
20. Fire detection and alarm systems	28
21. Other fire safety measures	30
22. Fire-fighting	30
23. Benchmark standards	31
24. Developments in fire safety technology and practice	32
Part C: The law governing fire safety in blocks of flats	34
25. Relevant legislation	35
26. Building Regulations	35
27. Housing Act 2004	36
28. Regulatory Reform (Fire Safety Order) 2005	37
29. Overlap of legislation	39
Part D: Fire risk assessment	41
30. Introduction	42
31. Requirement for a fire risk assessment	42
32. What is a fire risk assessment?	42
33. Common misconceptions about fire risk assessments	42
34. Scope of a fire risk assessment	44
35. Types of fire risk assessment	44
36. The risk assessment process	46
37. The action plan	47
38. Who should carry out the fire risk assessment?	48
39. Competence of professional fire risk assessors	48

40. Review of fire risk assessments	49
Part E: Managing fire risk – preventing fires	51
41. Introduction	52
42. Smoking	52
43. Arson	53
44. Housekeeping	55
45. Recycling	61
46. Electrical hazards	62
47. Heating and ventilation systems and equipment	64
48. Lightning	65
49. Other causes	65
Part F: Managing fire risk – fire protection	66
50. Introduction	68
51. Limitations of this guidance	68
52. Methodology for using benchmarks	68
53. Third-party certification	71
54. Compartmentation	71
55. Means of escape	75
56. Means of escape within the flat	75
57. Escape routes within the common parts	84
58. Escape from flats with internal corridor or lobby approach	84
59. Escape from flats with external balcony or deck access approach	90
60. External stairways	91
61. Escape routes over roofs	91

62. Blocks of flats that do not meet the current design benchmarks for means of escape	94
63. Fire safety signs	101
64. Lighting on escape routes	102
65. Refuse and chute rooms	102
66. Fire detection and alarm systems	103
67. Fire extinguishing appliances	104
68. Security locks and access systems	105
69. Flats in mixed-use buildings	106
70. Sheltered housing	107
71. Fire-fighting facilities	110
72. External fire-spread	111
Part G: Managing fire risk – ongoing control	112
73. Introduction	113
74. Responsibility for fire safety in the building	114
75. Access to competent advice on fire safety legislation	114
76. Coordination with other occupiers	115
77. Engaging with residents	115
78. Instruction, training and information for non-residents	117
79. Preparing for emergencies	118
80. Controlling hazardous activities	121
81. Inspection, testing and maintenance of fire safety systems and equipment	122
82. Inspections and repairs of other fire safety measures	125
83. Monitoring the common parts and being alert to new hazards	127
84. Reviewing and auditing fire safety standards	128

85. Controlling alterations so that they are not detrimental to fire safety	129
86. Being alert to possibilities of improving fire safety standards	130
87. Maintaining records	131
88. Liaising with agencies responsible for fire safety	132
Appendix 1: History of fire safety design standards for purpose-built blocks of flats	133
Appendix 2: Steps in a fire risk assessment	146
Appendix 3: Selecting a competent professional fire risk assessor	150
Appendix 4: Fire safety advice for residents	152
Appendix 5: Examples of fire action notices	154
Appendix 6: Fire detection and fire alarm systems for blocks of flats	156
Appendix 7: Case study – Three-storey block, with flats opening directly onto single stairway	161
Appendix 8: Case study – Five-storey block, with excess travel distance and other issues	163
Appendix 9: Case study – Nine-storey block, with inadequate smoke control and other issues	165
Appendix 10: Case study – Mixed-use block, with inadequate compartmentation	168
Appendix 11: Case study – Block containing two-storey flats, without adequate alternative exits	170
Appendix 12: Case study – Block containing single storey flats, without adequate alternative exits	172
Appendix 13: Case study – Three-storey leasehold blocks with uncooperative leaseholders	175
Glossary	177
Bibliography	181
Index	185

Acknowledgements

Local Government Group entrusted responsibility for this guide to a sector-led group of stakeholders, comprising:

Accreditation Network UK	ANUK
Association of Residential Managing Agents	ARMA
Association of Retained Council Housing	ARCH
Chartered Institute of Environmental Health	CIEH
Chartered Institute of Housing	CIH
Chief Fire Officers' Association	CFOA
Department for Communities and Local Government	DCLG
Electrical Safety Council	ESC
Federation of Private Residents Associations	FPRA
Homes and Communities Agency	HCA
Leasehold Advisory Service	LEASE
London Councils	
National Federation of ALMOs	NFA
National Housing Federation	NHF
National Housing Maintenance Forum	NHMF
National Landlords Association	NLA
Office of the Chief Fire and Rescue Adviser	CFRA
Residential Landlords Association	RLA
Royal Institution of Chartered Surveyors	RICS
Tenant Services Authority	TSA
Universities UK	

This guide was drafted for LG Group by CS Todd & Associates Ltd, who consulted with, and received comment from, a number of individuals, professional bodies, trade associations and others, the assistance of whom is gratefully acknowledged. Photographs and diagrams in this guide are reproduced with the kind permission of those responsible for the premises and the following:

- Association for Specialist Fire Protection (ASFP)
- Homes for Islington
- Guinness South
- O & H Properties
- Gerda Security Products Ltd
- Roché Systems Ltd
- Lorient Polyproducts Ltd
- Department for Communities and Local Government
- Norberne Seals Ltd
- Mr S Jacques

Introduction

1. Responsibility for this guide

- 1.1 The guidance in this document has been subject to an extensive consultation exercise. The final content has received input from representative groups from the housing sector as well as the Department for Communities and Local Government and the Chief Fire Officers' Association.

2. Purpose

- 2.1 This document is a guide to ensuring adequate fire safety in purpose-built blocks of flats, regardless of age. Practical advice is offered on how to assess the risk from fire and how to manage fire safety in such buildings. The document also includes case studies based on the commonly found issues in blocks of flats, with suggested fire safety solutions.
- 2.2 This guide does not introduce new standards or regulations, but builds on existing good practice and guidance currently in place. In particular, it will help landlords, managing agents, enforcing officers and those undertaking fire risk assessments to understand the legislative requirements relating to blocks of flats and to apply them in a consistent and reasonable manner.
- 2.3 This document does not set prescriptive standards. Its aim is to provide guidance and recommendations for use when assessing the adequacy of existing fire safety provisions in purpose-built blocks of flats.
- 2.4 While it includes definitive criteria for determining the level of safety, these are only intended to act as useful benchmarks against which comparisons can be made. Similarly, the methodology outlined here is only intended to assist in making such comparisons. Alternative fire risk assessment methods may be equally valid in order to comply with fire safety law. Alternative approaches to individual fire safety solutions may be acceptable as long as an equivalent level of safety is achieved.
- 2.5 It should be noted that building design varies considerably and no guide can ever provide specific solutions for all possible circumstances. Accordingly, this guide sets out only general principles.
- 2.6 While aimed at a broad readership, its use in assessing risk and determining an appropriate package of fire safety provisions in some buildings may require particular

knowledge and experience. It may be necessary to seek specialist help. Users of this guide should consider whether they have the necessary competence before applying this guide to a particular building.

3. Scope of this guidance

- 3.1 This guide is intended for buildings which have been constructed as purpose-built blocks of flats. It applies to existing blocks only. Fire safety design in new blocks of flats is governed by the Building Regulations 2010¹, but, once a block is occupied, this guide is applicable.
- 3.2 The scope of this guide excludes buildings converted into blocks of flats. However the guidance contained in this document will largely be applicable to such buildings, provided that – at the time of conversion – the work was carried out in accordance with the then current Building Regulations. In particular the guidance is likely to be relevant to conversions in which, as a result of compartmentation, a ‘stay-put’ policy is appropriate.
- 3.3 Within this guide, the term ‘flat’ is used to describe a self-contained domestic dwelling within a building. Other terms, such as ‘apartment’, are commonly used to describe such accommodation. The term ‘flats’ is intended to include those arranged on more than one storey, such as maisonettes (duplex apartments).
- 3.4 This guide also includes flats within sheltered housing schemes and blocks containing flats intended for multiple occupation by, for example, students or key workers. However, the guide does not address buildings of this nature in which, in the event of a fire in a flat, the entire building is evacuated simultaneously.
- 3.5 The guide does not address:
 - dwelling houses and bungalows
 - shared houses
 - HMOs
 - hostels
 - flats used as holiday lets.
- 3.6 This guide does not address ancillary or communal facilities, such as a lounge, gym or a hairdresser in a sheltered housing scheme. Although such facilities must be included in the scope of the fire risk assessment for the block, the fire precautions should be considered on a case-by-case basis, following general guidance applicable to buildings other than flats.

¹ Guidance to Part B of these Regulations (Fire Safety) for blocks of flats is contained in the DCLG publication ‘Approved Document B Volume 2’.

- 3.7 The guide does cover blocks with flats located above commercial premises, such as hotels and shops. However, guidance on fire safety in the commercial element is outside the scope of the document.
- 3.8 While the guide includes fire safety within the flats themselves, this only applies to flats occupied as single-family households. A flat in multiple occupation is a form of HMO and is, therefore, outside the scope of the guidance in this document.
- 3.9 This guide applies to purpose-built blocks of flats regardless of the tenure of the flats (ie whether owner-occupied, social housing or private rented sector). The term ‘residents’ is used when referring to the occupants of the flats. This is intended to cover all those who live in the building, whether tenants or leaseholders. However, the term ‘tenant’ is used when specifically referring to tenants, but not other forms of resident.
- 3.10 The guide is concerned only with the safety of those who live in, visit, or work in blocks of flats. It is also restricted to those lawfully on the premises.
- 3.11 It does not provide guidance on protecting property. Nor does it include recommendations specifically to address certain consequences of fire, such as the need to re-house residents at short notice.
- 3.12 By virtue of including guidance on the provision and maintenance of facilities for use by fire and rescue services in fighting fires in blocks of flats, the needs of fire-fighters are, to some extent, covered in this guide. However, the document is not a guide to operational fire-fighting in such buildings.
- 3.13 The guide applies only to England. However, it is likely to be relevant in Wales, where the same fire safety legislation applies.

4. Intended readership

- 4.1 This guide is particularly aimed at those who manage, give advice on and enforce standards in purpose-built blocks of flats. This specifically includes those undertaking fire risk assessments of such buildings, including those contracted to do this on a commercial basis.
- 4.2 Typically, this will include:
- private sector housing providers (landlords)
 - social housing providers
 - residents’ management companies
 - ‘Right to Manage’ companies
 - managing agents or facility managers
 - enforcement officers in local housing authorities

- enforcement officers in fire and rescue authorities
- advice agencies
- consultants and contractors carrying out fire risk assessments.

- 4.3 The guide is not specifically intended for residents. However, it is recommended in the guide that landlords and others responsible for managing fire safety in blocks of flats should engage and communicate with those who live in the buildings in their care.
- 4.4 It is recognised that some readers will be primarily interested in the practical application of this guide as it relates to managing fire safety in blocks of flats. Accordingly, particular advice of this nature is highlighted in the text and, where appropriate, key points are summarised. This can be found in the shaded boxes. However, to achieve an adequate standard of fire safety, it is important that all sections of the guidance are taken into account.

5. Relationship to other guidance

- 5.1 This sector-led guide has been developed by, and for, the housing sector and enforcing authorities, to provide specific guidance relating to purpose-built blocks of flats. It builds on the advice given in the DCLG Sleeping accommodation guide mentioned earlier. That guide applies generically to all premises in which people sleep, but, for purpose-built blocks of flats, this guide is likely to be the more appropriate one to use.
- 5.2 Certain blocks of flats are also included within the scope of the LACoRS guide ‘Housing – fire safety: guidance on fire safety provisions for certain types of existing housing’. However, the blocks addressed in that document comprise purpose-built blocks and conversions that, in either case, do not meet the standards applied under the Building Regulations since 1992.
- 5.3 This present guide covers all purpose-built blocks of flats (both common parts and the flats themselves), including those within the scope of the DCLG and LACoRS guides. It is, therefore, the more appropriate guide to use for purpose-built blocks of flats.

6. Layout of the guide

- 6.1 The guide is laid out as follows.

Part A contains an analysis of fires in purpose-built blocks of flats.

This is intended to put the risk from fire in these buildings into context and draw comparisons with the risk to people living in other forms of housing.

Part B outlines the general principles of fire safety in purpose-built blocks of flats.

This is aimed at informing the reader about the basis of fire safety design in such buildings. It highlights how fires can develop and spread if suitable precautions are not taken. And it looks at why fires in blocks of flats can potentially be seen as more serious.

It is always intended that the occupants of a flat where a fire occurs should evacuate immediately. The concept of 'stay put' as a strategy, where other residents remain in their flats, is explained here along with the implications this has for building design.

The alternative of evacuating some or all of the other residents at the same time is also discussed. The particular differences that might apply in special circumstances, such as sheltered housing schemes, are also highlighted.

Part C provides an overview of the legal framework in relation to fire safety in purpose-built blocks of flats.

In particular, it aims to help landlords, and those managing fire safety in these buildings, to understand their obligations under housing legislation, as well as under the FSO. The extent of these obligations, particularly where, under a lease, landlords do not have control over certain fire safety provisions, is also addressed.

Part D outlines the principles and methodology of fire risk assessment.

This is aimed not only at those undertaking such assessments, but also enforcing authorities responsible for auditing them. It is also intended to assist landlords and others when commissioning third parties to carry out fire risk assessments on their behalf.

While there is other guidance available on fire risk assessment, the focus here is on its specific application to these types of premises. It includes guidance on the following aspects of the fire risk assessment process:

- who should carry out a fire risk assessment and what level of competence is required
- what fire risk assessments should cover, particularly in relation to fire safety within the flats themselves
- how intrusive they should be with regard to assessing aspects of the construction of the building
- when they should be carried out and how often they should be reviewed
- how they should be recorded.

Parts E and F describe how various fire safety measures may be applied to reduce risk.

In Part E, beginning with fire prevention, a series of practical measures are outlined to address the commonly found fire hazards in blocks of flats. This is particularly aimed at landlords and those managing fire safety in blocks of flats. However, it will also serve to

inform those giving advice about a reasonable approach on particular issues.

While concentrating on the hazards arising in the common parts, reference is made to sources of guidance available to residents.

Part F outlines benchmarks relating to various fire safety measures employed in fire safety design to make a building safe. These measures include:

- escape route design
- compartmentation
- smoke control provisions
- facilities for the fire and rescue service when fighting fires.
- To the extent that they may be necessary, other aspects also addressed here are:
- fire detection and alarm systems
- emergency escape lighting
- fire extinguishing appliances
- fire safety signs.

However, as discussed in this part – with the exception of emergency escape lighting – such measures will not often be necessary and will need to be considered on a case-by-case basis.

A methodology is included for comparing the standard found in the building to that of the benchmarks set out in this part of the guide.

To illustrate the application of this approach, case studies are included in the appendices. These are only examples of fire safety solutions for particular sets of circumstances. Other solutions may be equally valid and, accordingly, those described must not be used as ‘off-the-peg’ solutions.

Part G is particularly aimed at landlords and others with the responsibility for the ongoing control of fire safety in blocks of flats. It will also be useful to those considering the standard of fire safety management when assessing risk.

Advice on the possible need for emergency plans and fire procedures is given. This includes suggestions for engaging with tenants and residents to improve awareness of hazards and preparedness for fire emergencies. The benchmarks for testing and maintaining fire safety provisions are included with good practice on what should be recorded and how records should be kept.

This part also includes guidance relating to changes that might introduce new risks. Alterations to buildings can inadvertently affect fire safety standards, and examples of where this might occur are given.

7. Appendices

7.1 Various appendices provide a reference source for readers.

These comprise:

- a history of fire safety design standards for blocks of flats
- the steps involved in a fire risk assessment
- selection of a competent fire risk assessor
- fire safety advice for residents
- sample fire action notices
- fire detection and fire alarm systems for blocks of flats
- case studies illustrating the application of the guidance to various situations commonly found in existing blocks of flats.

8. Glossary

8.1 The glossary is intended as a plain English guide to some terms used in this document.

9. Bibliography

9.1 The bibliography offers sources of further reading for those seeking greater detail or researching the source of some of the guidance. It also lists the full titles of all references included in the guide.

Part A: Safe as houses? Fires in flats and their impact

Key points

- People living in flats experience more fires than people living in houses. However, a fire in a flat is no more dangerous than a fire in a house.
- High-rise does not mean high-risk!
- To keep fire risk to a minimum, it is just as important to prevent fires as to provide measures to protect people when fire occurs.
- The most significant influences on fire risk are social and lifestyle factors and advanced age, not the type of dwelling in which people live.
- All dwellings should have working smoke alarms.
- Very few people die as a result of a fire in a neighbour's flat or the common parts. Nearly all fire deaths occur in the flat in which fire starts.
- In blocks of flats, each flat is designed to be a fire-resisting 'box'. It is important to maintain the integrity of this compartment, particularly when building work and alterations take place.
- It is important to ensure that fires cannot start in the common parts or common facilities.

10. Fires in domestic dwellings

10.1 Generally, people are safer from fire in their homes than at any time in recent history. In 1979, 865 people in the UK died from fires in dwellings. Nearly thirty years later, the number of deaths had fallen to 353, a reduction of 60 per cent, and the lowest figure since official records began in 1960.²

10.2 This significant reduction in domestic fire deaths is almost certainly the result of a number of factors, one of the most important of which is the great increase in the provision of smoke alarms in homes. There is overwhelming evidence to show that, where occupants of a dwelling are given an early warning of fire by a smoke alarm, the chance of anyone dying is greatly reduced. Another important factor is legislation to control the flammability of domestic furniture.

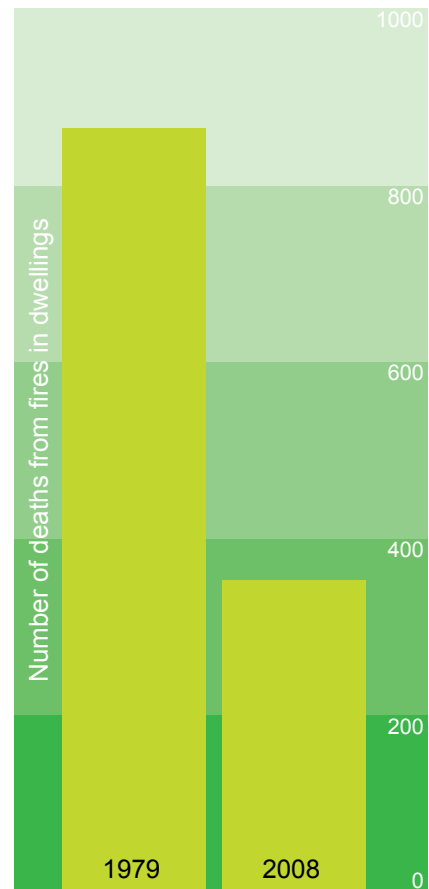

10.3 In addition, undoubtedly many lives have been saved by government, and individual fire and rescue services' 'community fire safety' (CFS) initiatives. CFS involves proactive efforts to reduce the incidence and impact of fire through education, information and publicity. Significant CFS initiatives include the provision of smoke alarms to householders, education in schools and free home fire-safety checks.

11. Relative risk in flats

11.1 In England, around 10 per cent³ of the population live in a purpose-built flat. Yet, during 2009-2010, around 25 per cent of dwelling fires occurred within purpose-built blocks of flats. As a result, in that year, 23 per cent of all fire deaths in dwellings occurred in these blocks.



² Source: UK Fire Statistics 2008

³ Source: 2001 Census and English Housing Survey (2009-2010)

- 11.2 This suggests that the number of fire deaths in purpose-built flats appears significantly disproportionate to the number of people who live in these dwellings. But this is simply the result of number of fires in such dwellings, most of which are started accidentally. There is no evidence from fire statistics to suggest that those living in purpose-built blocks of flats are at greater danger from fire, once it breaks out, than those who live in houses⁴.
- 11.3 Once a fire occurs in a block of flats, the likelihood of a death is actually less than the likelihood of a death when fire occurs in a bungalow or a house. The lower frequency of deaths when fire occurs is paralleled by a lower rate of injury. One possible reason for this is that greater protection is afforded to escape routes in flats than in bungalows and two-storey houses.
- 11.4 In addition, because, in a block of flats, each individual flat is totally enclosed in fire-resisting construction, the vast majority of fires are contained within the flat (and, in the majority of cases, the room) where they start. It is certainly rare for anyone, outside the flat where a fire starts, to die as a result of a fire in a flat.

12. Is 'stay put' safe?

- 12.1 This is the basis for the 'stay put' principle (discussed later in this guide): when a fire occurs within one dwelling (or, less likely, in the common parts), it is normally safe for other residents to remain within their own flat. This principle is undoubtedly successful in an overwhelming number of fires in blocks of flats. In 2009-2010, of over 8,000 fires in these blocks, only 22 fires necessitated evacuation of more than five people with the assistance of the fire and rescue service⁵.

13. High-rise equals high-risk?

- 13.1 There is a common misconception that those living on the higher levels of a high-rise block of flats are at greater risk from fire than people living in low-rise blocks, or in bungalows and two-storey houses. However, statistically, there is no evidence to support this, even though, in principle, the potential risk might be regarded as greater.
- 13.2 Obviously, above first floor level, escape via windows is impossible, and, above the third floor, rescue by fire and rescue service ladders is unlikely to be possible; even high reach appliances have their limits. However, this is taken into account in the design, layout and means of escape in modern blocks of flats. They are designed so that escape or rescue via windows should not be necessary.

4 Source: Fire and Rescue Service Incident Reporting System Data 2009-2010

5 Source: Fire and Rescue Service Incident Reporting System Data 2009-2010

- 13.3 There is evidence to suggest that taller blocks experience more fires (eg per 1,000 dwellings) than blocks of lower height. However, more fires occur on the ground floor than on any of the higher floors. Again, once fire does break out, there is no greater likelihood of a fatality in a high-rise block than in a low-rise block. In fact, fire statistics show that a fire in a bungalow is more likely to result in a fatality than a fire in a high-rise block of flats (because of the age demographic of those living in bungalows).
- 13.4 Therefore, as in all dwelling types, the risk to people from fire (ie risk of death or injury) in a block of flats is governed primarily by the likelihood of fire occurring and whether smoke alarms are installed, rather than the type of dwelling in which people live, the height of the dwelling above ground or the architectural design of the block.

14. Factors influencing the likelihood of a fire

- 14.1 The likelihood of fire is strongly influenced by social and lifestyle factors. It is these factors, more than any other, that result in the disproportionate number of fires (and fire deaths) in blocks of flats.
- 14.2 This highlights the importance of fire prevention within the individual flats. It is also clear that much can be done by landlords, other housing providers and the fire and rescue service (through their CFS activities) to reduce the risk to all residents. This is particularly true in the case of the most vulnerable people, such as older or disabled people, socially deprived people and those who engage in drug or alcohol abuse.
- 14.3 The assessment of risk from fire also needs to take social factors into account, particularly in the case of accommodation provided specifically for certain high-risk groups. Guidance on fire risk assessment is given in Part D of this guide, while measures to prevent fire occurring are discussed in Part E of this guide.
- 14.4 Notwithstanding the importance of fire prevention, to ensure that, in any block of flats, when a fire occurs the risk to people is minimised, various fire safety measures need to be provided. These are specific to blocks of flats, and take account of the differences between flats and traditional houses. The principal differences are discussed in Part B of this guide.

Part B: Fire safety – how blocks of flats differ from other residences

Key points

- While escape within flats is based on similar principles to those for houses, reaching ultimate safety relies on using the common parts.
- Most blocks of flats are designed on the 'stay put' principle. Although this relies on there being effective compartmentation, it is a principle that should be adopted wherever possible.
- Provided there is effective compartmentation and means of escape, 'general needs' blocks of flats will not normally require a communal fire alarm system.
- Communal fire alarm systems should not be installed unless it can be demonstrated that there is no other practicable way of ensuring an adequate level of safety. If such a system is provided, it must be possible to manage it.
- However, it should not automatically be assumed that constructional standards will be inadequate in the absence of evidence to that effect.
- Proposals to upgrade fire protection in an existing block should aim to ensure, or restore, a satisfactory standard of compartmentation in order to maintain the original 'stay put' policy.
- More generally, application of current benchmark standards to an existing block of flats is not normally appropriate.
- Certain developments in fire safety technology and practice (eg smoke alarms within flats) should be adopted. However, other developments such as automatic suppression systems will only be appropriate if the cost and effort of adopting them is proportionate to the risk.

15. Introduction

- 15.1 With all the facilities and amenities needed for independent living, a flat is no different in many respects to any other form of dwelling. As demonstrated in Part A of this guide, the risk to people from a fire within their flat is no greater than for those living in other forms of dwelling.
- 15.2 The potential for fire to spread from one flat to another has long been recognised. While fire safety standards have developed over the years, they have always aimed to ensure that the level of safety for those living in blocks of flats is equivalent to that for those living in houses. Fundamental to this is the ability to escape safely.

16. Means of escape

- 16.1 The fundamental objective in escape route design is that it should be possible to escape unaided while it is still safe to do so. A person's ability to escape will be affected by both the smoke and the heat from a fire. Smoke not only reduces visibility, but can, because of the toxic gases and irritants in the smoke, cause incapacitation. High temperatures and radiant heat from the flames will also impact on people's ability to escape. Recognising these hazards and meeting this objective underlies fire safety design in all buildings. It applies equally to dwellings.
- 16.2 There are situations in which fire and rescue services need to rescue people by using ladders. While some dwellings, including those within blocks of flats, are within reach of ladders or high-reach appliances, many are not. In addition, modern traffic conditions, including congestion and restricted access due to parking, can significantly impact on the ability to carry out such rescues. It is, therefore, a fundamental principle that escape route design should not rely on external rescue by the fire and rescue service.
- 16.3 To enable people to leave in time, most houses are designed with an alternative means of escape if the occupants cannot use the normal way out of the dwelling. Alternatively, to ensure that it can be used safely, the main exit route is 'protected', ie enclosed in fire-resisting construction. In bungalows and two storey houses, windows are recognised as an alternative means of escape.
- 16.4 Dropping from a window is not, of course, a feasible option in the case of blocks of flats above two storeys in height. Alternatives in this case usually involve access to a stairway, even if via a corridor or linking balcony. Using a linking balcony to gain access to a neighbour's flat has been an approach used in the past but is now considered unsuitable.
- 16.5 It is, however, possible to design a block of flats without alternative means of escape from the flats. Indeed, this is by far the norm. Even in blocks with two or more stairways, it is often necessary to escape from the flat into a single common corridor to reach both stairways.

- 16.6 In these cases, limitations on the size and layout of the flats normally apply, with restrictions on the overall distance from the front door to the furthest part of the flat. Alternatively, a protected entrance hall is provided to safeguard the internal route of escape from each habitable room to the front door. Again, limits are applied to the length of such corridors.
- 16.7 While it is clear from the above that the internal escape from flats is designed on similar principles to that of houses and bungalows, the key difference in fire safety design in a block of flats relates to the fact that, once out of the flat, there is further to go to reach ultimate safety. Escape for residents therefore depends on the common parts being suitably designed and maintained for use in an emergency.
- 16.8 While the flats, themselves, are outside the scope of the FSO, those elements of the common parts that afford escape for residents once outside their flats are included (see Part C of this guide).
- 16.9 Design of communal means of escape in purpose-built blocks of flats is based on certain assumptions. These include:
- the most likely place of origin of a fire will be in a flat itself
 - that there is a high degree of fire separation between flats and the common parts and, therefore, the likelihood of fire and smoke spread beyond the flat of origin is low
 - the materials used in the construction of the building or the protection afforded to them are such that fire is unlikely to spread through the fabric of the building
 - that the use of the common parts, and the nature of any combustible items present, is such that any fire originating in the common parts is unlikely to spread beyond the immediate vicinity
 - there will be no external rescue, and residents should be able to escape by themselves.
- 16.10 These assumptions dictate the appropriate protection for the communal means of escape.

As a result, the following principles would normally be incorporated in the design of escape routes in a block of flats.

- Front doors to flats need to be fire-resisting and self-closing.
- Corridors leading to stairways need to be enclosed in fire-resisting construction.
- Where there is only escape in one direction along a corridor, the extent of travel in such 'dead ends' needs to be limited.
- Open decks and balconies need to be limited in extent if escape is only possible in one direction, with fire-resisting construction to protect people passing other flats to reach a stairway.
- Stairways need to be enclosed in fire-resisting construction, with fire-resisting, self-closing doors.
- Any external stairways need to be suitably separated from the building by fire-resisting construction and doors.
- Any areas, rooms or risers opening onto communal escape corridors and stairways need to be fitted with fire-resisting doors that are self-closing or kept locked shut.
- Arrangements for maintaining stairways clear of smoke need to be provided (through means such as openable windows and vents).
- Additional protection is needed where there is only a single stairway for normal access and for egress in an emergency, normally comprising lobby approach and permanent openings or automatically opening vents for clearing smoke.

16.11 Older people and people with certain disabilities may require particular consideration to be given to their needs in the event of fire. Meeting people's needs for normal living may mean that, in certain cases, specially adapted dwellings need to be provided, for example, on the ground floor. Sheltered housing is clearly an example of purpose-built accommodation intended for people with a particular set of needs. Accordingly, fire safety design in such buildings includes consideration of the implications for means of escape and other fire safety measures.

16.12 However, it is reasonable to expect that the occupants of a 'general needs' block of flats will reflect the diverse range of physical and mental capabilities of the general population as a whole. Although inclusive design is fundamental to new 'general needs' purpose-built blocks, the Building Regulations do not stipulate additional fire safety measures that must be provided as a consequence.

16.13 In many circumstances, it will be impracticable to make special provision retrospectively, with regard to fire safety design in existing blocks of flats, to address the nature of the occupants. However, it is generally considered unacceptable for landlords – and others who own or manage blocks of flats – to exclude people from the building

because of factors such as disability and age. Fire safety should not be used as a reason for this. Guidance of a specific nature that may be considered for the protection of disabled people can be found in various parts of this guide.

17. Compartmentation

17.1 The high degree of fire separation between flats and the common parts is achieved by making each flat a fire-resisting enclosure. This is known as compartmentation. A compartment is simply a part of a building bounded by walls and floors that will resist the passage of fire for a specified period of time. The fire resistance of this construction is such that, normally, a fire will burn itself out before spreading to other parts of the building.

17.2 Compartmentation minimises the likelihood of fire spreading:

- from a flat to the escape routes (common parts)
- from flat to flat
- beyond communal rooms and facilities, such as plant rooms and bin stores
- via concealed voids, including external wall cavities
- via common service risers and ducts
- via rubbish chutes
- via lifts
- from any car-parking areas below
- from other occupancies where the block is part of a mixed use development eg above shops or a hotel.

17.3 The building's elements of structure are required to possess sufficient fire resistance when exposed to a fire of predicted severity to not only prevent fire-spread, but also to prevent structural collapse.

It needs to be ensured that the fire-resisting enclosure of flats is maintained at all openings, including:

- flat entrance and other doors
- any internal windows into the access corridor, or any glazing above or around the flat entrance door
- openings in walls and floors for services, such as water, gas and electricity
- vents into shared air supply ducts, but, more commonly, shared extract ducts from bathrooms and sometimes kitchens

- openings in walls and floors for communal heating systems, including ducted warm air systems, as well as hot water supplies
- doorways or hatches in walls for access to read electricity and gas meters and for deliveries and collections.

18. Evacuation strategy

- 18.1 The compartmentation between flats is analogous to the party wall separation between adjoining houses, which prevents fire-spread from one house to another. It also enshrines the principle that a person's actions, while they may affect their own safety, should not endanger their neighbours.
- 18.2 Compartmentation requires a higher standard of fire resistance than that normally considered necessary simply to protect the escape routes. This is to ensure that a fire should be contained within the flat of fire origin. Accordingly, those in flats remote from the fire are safe to stay where they are. Indeed, in the majority of fires in blocks of flats, residents of other flats never need to leave their flats.
- 18.3 This is the essence of the 'stay put' principle. It has underpinned fire safety design standards from even before the 1960s, when national standards were first drafted. It still the basis upon which blocks of flats are designed today. In the majority of existing blocks, it remains entirely valid.
- 18.4 Inevitably, fires do occur in which, for operational reasons, the fire and rescue service decides to evacuate others in the building. Fires have been known to spread beyond the flat of origin to involve other flats or to spread across the top of blocks through the roof voids. In these cases, total evacuation of the block has sometimes been necessary. Fortunately, these fires are rare. They are usually the fault of failings in the construction.

19. 'Stay put' policy

- 19.1 A 'stay put' policy involves the following approach.
- When a fire occurs within a flat, the occupants alert others in the flat, make their way out of the building and summon the fire and rescue service.
 - If a fire starts in the common parts, anyone in these areas makes their way out of the building and summons the fire and rescue service.
 - All other residents not directly affected by the fire would be expected to 'stay put' and remain in their flat unless directed to leave by the fire and rescue service.

- 19.2 It is not implied that those not directly involved who wish to leave the building should be prevented from doing so. Nor does this preclude those evacuating a flat that is on fire from alerting their neighbours so that they can also escape if they feel threatened.
- 19.3 The alternative to a 'stay put' policy is one involving simultaneous evacuation.
- 19.4 Simultaneous evacuation involves evacuating the residents of a number of flats together. It requires a means to alert all of these residents to the need to evacuate, ie a fire detection and alarm system. Purpose-built blocks of flats are not normally provided with such systems.
- 19.5 Simultaneous evacuation is sometimes applied to buildings converted into blocks of flats, but usually only where it has not been possible to achieve the level of compartmentation required for a 'stay put' policy. In purpose-built blocks of flats, experience has shown that most residents do not need to leave their flats when there is a fire elsewhere. Indeed, in some circumstances, they might place themselves at greater risk when they do so.
- 19.6 Some enforcing authorities and fire risk assessors have been adopting a precautionary approach whereby, unless it can be proven that the standard of construction is adequate for 'stay put', the assumption should be that it is not. As a consequence, simultaneous evacuation has sometimes been adopted, and fire alarm systems fitted retrospectively, in blocks of flats designed to support a 'stay put' strategy.
- 19.7 This is considered unduly pessimistic. Indeed, such an approach is not justified by experience or statistical evidence from fires in blocks of flats (see Part A of this guide). It also differs from the principles of fire risk assessment (see Part D of this guide). Accordingly, proposals of fire risk assessors, and requirements of enforcing authorities, based on a precautionary approach (eg abandonment of a 'stay put' policy simply because of difficulties in verifying compartmentation), should be questioned. Before committing resources, it might be appropriate to seek a second opinion.

20. Fire detection and alarm systems

- 20.1 Early warning of fire is an essential component of ensuring that residents can evacuate safely from their flats in a fire. In Part A of this guide, the success of smoke alarms in cutting the number of casualties in fires in dwellings was highlighted. Provision of appropriate smoke (and sometimes heat) alarms is now considered a basic component of fire safety design for flats.
- 20.2 Although purpose-built blocks of flats are not normally provided with communal fire detection and alarm systems, there are exceptions. The most common example is a sheltered housing scheme, but this is a special case, and, even then, a 'stay put' policy is normal.

- 20.3 Fire detection may also be provided in order to operate automatically opening vents to clear smoke from common areas. However, these systems do not incorporate means to warn the occupants of flats.
- 20.4 In 'general needs' blocks designed to support a 'stay put' policy, it is unnecessary and undesirable for a fire alarm system to be provided. A communal fire detection and alarm system will inevitably lead to a proliferation of false alarms. This will impose a burden on fire and rescue services and lead to residents ignoring warnings of genuine fires.
- 20.5 A fire alarm system ought to be provided only in a building in which some control can be achieved over the occupants to ensure that they respond appropriately. For most blocks of flats, it would be unrealistic to expect this. Nor is it necessarily desirable that evacuation should take place from areas remote from the fire, unless and until these areas themselves become threatened by the fire.
- 20.6 The ability to manage a fire alarm system is rarely possible in a block of flats unless staffed at all times, eg by a concierge or caretaker. Allowing residents to silence and reset a system is inappropriate in these circumstances. Access to use of these facilities also enables major disablement of a fire alarm system. This could expose landlords and others with responsibility for managing fire safety to liability if, through the actions of a resident, the system is left inoperative and fails to perform correctly in the event of a fire.
- 20.7 In view of the above, only in unusual circumstances will a communal fire detection and alarm system be appropriate for a 'general needs' purpose-built block of flats.
- 20.8 These could include:
- where it can be demonstrated that the assumptions and principles outlined earlier are not met and cannot readily be achieved
 - where the flats are not sufficiently separated from commercial premises below.
- 20.9 It may not always be necessary to adopt simultaneous evacuation when providing a communal fire alarm system (see Appendix 6). There may be circumstances in which the objective of the system is to compensate for a particular shortcoming in an aspect of, say, escape route design or compartmentation in a building, which otherwise is suitably designed for a 'stay put' policy. In these cases, it may, for example, only be necessary to alert the fire and rescue service in the event of activation of the system.
- 20.10 Use of such systems will only be applicable in specific circumstances, and will require careful consideration by those carrying out a fire risk assessment. Fire alarm systems should only be fitted in existing blocks of flats where there is clear justification, and only as a last resort when it is impossible to upgrade other measures to enable a 'stay put' policy to be adopted.

21. Other fire safety measures

- 21.1 There should be adequate illumination of escape routes to be able to see the way out in an emergency. With the possible exception of small two-storey blocks of flats, with good borrowed light from, for example, street lighting, blocks of flats should be provided with emergency escape lighting.
- 21.2 Similarly, fire exit signs might need to be displayed to assist in the use of an escape route with which people are unfamiliar. In a single stairway building, there is rarely a need for such signs. It is not usually considered necessary to signpost the route that residents normally use to gain access to their flats.
- 21.3 It is rare for there to be a need for fire-fighting equipment to be used by people present in the common parts of blocks of flats. It is, nevertheless, usually provided in plant rooms and other such rooms, for use by the staff and contractors.
- 21.4 The provision of fire extinguishers and other forms of fire-fighting equipment in common parts for use by residents is problematic. It is not expected that residents should need to tackle a fire in their flats to make their escape. Indeed, to obtain a fire extinguisher located in the common parts for this purpose would involve the person leaving their flat in the first place.
- 21.5 This does not preclude residents from providing their own fire extinguishers and fire blankets. Indeed, it may be appropriate for landlords, and others responsible for the common parts, to encourage this as part of the process of engaging with, and educating residents on, fire safety.

22. Fire-fighting

- 22.1 Special facilities for use by the fire and rescue service in effecting rescue and fighting a fire are provided in tall blocks of flats. These normally comprise suitably protected stairways and lobbies, specially designed lifts for use by fire-fighters and fire mains by which the fire and rescue service can obtain water.
- 22.2 Normally, the presence (or indeed absence) of these facilities has no direct bearing on the evacuation strategy of the block. It would not normally be appropriate to seek improvements to such facilities to address issues relating to escape route design and compartmentation in blocks of flats.

23. Benchmark standards

- 23.1 The assumptions and principles outlined above have underpinned fire safety design standards for many decades and, with some exceptions, still remain valid today. They are still the basis of current guidance for new blocks of flats.
- 23.2 While many of the design principles have not changed, there have been changes in the benchmark standards that are applied. There have also been changes to some of the approaches to applying these principles. For example, smoke dispersal by means of cross-ventilation is no longer accepted as an effective means of keeping common escape routes clear of smoke.
- 23.3 It is wholly inappropriate to impose the current guidance for new blocks of flats retrospectively to existing buildings. Nevertheless, current guidance can be considered when setting benchmarks against which to assess the adequacy of fire protection within existing blocks of flats.
- 23.4 However, it should be recognised that benchmarks are intended simply to make comparisons. Judgement is needed by fire risk assessors and others when reviewing fire safety in a particular block.
- 23.5 It will often need to be accepted that it is neither realistic to meet current benchmark standards, nor risk proportionate to impose many of the solutions available today to the situations found in the designs of existing buildings.
- 23.6 There have been many variations in the design of blocks of flats over the years. As a result, older blocks will not comply with current benchmark standards. Fire safety professionals may not be familiar with older designs that are not consistent with the standards of today.
- 23.7 It is recognised that, with older blocks, it can be difficult to discern what the original design intent was, and whether it has been preserved or altered subsequently. Similarly, it can also be difficult to determine what standard has been achieved, especially in relation to compartmentation, given that some of the relevant elements of structure are often hidden and inaccessible.
- 23.8 Nevertheless, when assessing the adequacy of fire protection in existing blocks of flats, it is considered essential to endeavour to determine the benchmark standards that applied when the block was built. It is important to establish just how far removed the original standards are to what is considered acceptable today, and whether this has given rise to an unacceptable level of risk.
- 23.9 This is needed to inform decisions regarding the need or otherwise to upgrade fire protection when considering the fire risk in a particular block.

23.10 Guidance on appropriate benchmark standards is given in Part F of this guide. This includes consideration of the many flat layouts and escape route designs that can be found in existing buildings. It includes a framework for comparing the standard of fire safety found in a building against these benchmark standards. Appendix 1 gives a brief history of the development of fire safety standards that have applied to purpose-built blocks of flats over the years.

24. Developments in fire safety technology and practice

24.1 There have been numerous developments since many of today's blocks of flats were built. Many buildings pre-date one of the most significant of these, the widespread use of smoke alarms in domestic dwellings.

24.2 Some elements of fire safety design are no longer considered acceptable, eg escape into a neighbour's flat via a linking balcony. Also, the approach taken to meeting fire safety principles has changed. For example, smoke containment is now preferred as the means of keeping common escape stairways clear of smoke, while smoke dispersal is deprecated.

24.3 New forms of smoke control, using mechanical means, rather than natural ventilation, have been introduced. For example, systems using pressurisation to keep escape routes clear are now available, and smoke extract systems are now being used in fire engineering designs for blocks of flats to facilitate extended travel within 'dead ends'.

24.4 Another key development has been the use of sprinklers. Although more commonly associated with other types of building, systems specifically intended for domestic and residential premises have been developed, along with appropriate standards to govern their use. Guidance under the Building Regulations now calls for blocks of flats over 30m in height to be fitted with sprinklers in the flats. Their use can also provide design freedoms, for example in open plan layouts.

24.5 Water mist systems are also now available. These too have been developed for domestic and residential applications as well as for more commercial and industrial applications.

24.6 The extent to which such developments in technology can, and should be, taken into account when assessing existing blocks of flats needs to be considered carefully. It is important that the cost, practicality and benefit gained are all taken into account. Strategies to address shortcomings in fire safety should be proportionate to the risk. This is a key principle in fire risk assessment (see Part D of this guide).

24.7 While smoke alarms can easily be retrofitted, other fire safety technology cannot always readily be applied to existing buildings. It is unlikely that retrofitting sprinklers or water mist systems would be reasonably practicable for existing blocks, nor would retrofitting

mechanical means of smoke control. Nevertheless, this does not preclude their use where there is clear justification and appropriate consideration of the practicalities of their installation and subsequent maintenance.

Part C: The law governing fire safety in blocks of flats

Key points

- Material alterations to existing blocks of flats, including alterations to individual flats, are controlled under the Building Regulations 2010, and need to be approved by a building control body otherwise an offence is committed.
- All residents of flats need to be made aware of the importance of maintaining in place the fire safety measures required by legislation at the time of construction of the block. Alterations by residents within their own flats may not only put those residents at risk, but also other residents in the block.
- Even if the block satisfied earlier legislation, proposed alterations must be considered in the light of the current Building Regulations; it is not sufficient to carry out alterations on the basis of the earlier legislation.
- Under the Housing Act 2004, the housing authority must inspect properties if they become aware of significant fire hazards. Housing authorities have powers of entry for this purpose.
- The housing authority may make requirements for improvements in fire precautions. In the event of serious risk, the housing authority has the power to take emergency remedial action.
- The FSO applies to all parts of a block of flats, other than within the individual flats.
- The FSO imposes duties on persons who may include freeholders, landlords, managing agents and contractors who maintain fire safety measures and those who carry out fire risk assessments.
- All fire safety measures must be adequately maintained.
- An offence is committed if inadequate fire safety measures place people at risk of death or serious injury in case of fire.

25. Relevant legislation

25.1 When a block of flats is designed and constructed, Building Regulations make requirements in respect of various fire safety measures. However, there is no ongoing control for the maintenance of these measures under Building Regulations; the regulations have no further effect until there are proposals for alterations. After the block is occupied, control of fire safety is transferred to the Housing Act 2004 and the Regulatory Reform (Fire Safety) Order 2005.

25.2 The above legislation and its application is discussed in this part of the guide.

26. Building Regulations

26.1 For blocks of flats, the Building Regulations 2010 make requirements for various fire safety measures, including means of escape, structural fire precautions, smoke control and facilities for the fire and rescue service. The Building Regulations apply to new building work, such as:

- erection of a new block of flats
- extension of an existing block
- material alterations.

26.2 It is important to understand the relevance of the current Building Regulations to alterations. Inappropriate and unauthorised alterations can undermine the measures provided to ensure safety of occupants from fire. 'Material alterations' must be approved by a building control body.

26.3 It can sometimes be difficult for the responsible person to judge whether or not an alteration is material. In practice, any proposals to carry out alterations – to fire alarm systems, means of escape or smoke control arrangements, structural alterations and alterations to facilities for the fire and rescue service – should be submitted to a building control body to determine if approval is necessary (and, if so, to obtain approval of the proposals) under the Building Regulations.

26.4 It should be noted that quite minor alterations and building works can often result in a contravention of the Building Regulations, which is an offence under the Building Act 1984. For example, removal of cross-corridor fire doors, or replacement of a fire door within a flat by a non-fire-resisting door, would normally result in such a contravention. Prosecution proceedings for such offences can be instituted for 24 months after completion of the unauthorised work.

26.5 A common contravention is the replacement of a self-closing, fire-resisting flat entrance door by a non-fire-resisting door or by a door that is not self-closing. This is a particularly serious contravention as it may place other residents at serious risk if a fire

occurs in the flat in question. This highlights the importance of making residents aware of their responsibilities to maintain in place the fire precautions originally required under the Building Regulations at the time of construction of the flats.

- 26.6 There is no requirement under the Building Regulations for upgrading existing fire safety measures to current standards. However, existing non-compliances with the current Building Regulations must not be made any worse in the course of alterations or building works.
- 26.7 Powers also exist under the Building Regulations to require unauthorised material alterations to be rectified if a breach of the Regulations resulted from the work. These powers only exist for 12 months after the work has been carried out. However, at any time, an application can be made to the local authority building control for 'regularisation' of unauthorised work carried out after 1985, enabling retrospective approval to be granted, subject to the work being satisfactory.

27. Housing Act 2004

- 27.1 The Housing Act 2004 makes requirements regarding the condition of a broad spectrum of housing, including both individual flats within a block and the common parts of that block (ie all parts of buildings to which this guide applies). Local housing authorities are the enforcing authority for this legislation.
- 27.2 Assessment of the conditions within flats or the common parts of blocks of flats is carried out by means of the Housing Health and Safety Rating System ('HHSRS') specified in the Act. The purpose of the HHSRS is to provide a means of assessment that identifies hazards and allows a judgement to be made as to whether the consequent risk to people is acceptable. A total of 29 hazards, including the hazard of fire, must be considered in carrying out the HHSRS. The assessment is carried out on each individual flat, rather than the entire block as a single building.
- 27.3 Assessed hazards are classified under the Act as either Category 1 or Category 2, according to the extent of risk to the most vulnerable occupants. Category 1 hazards create greater risk than Category 2 hazards. If a local housing authority becomes aware that a Category 1 or Category 2 hazard may exist, they are obliged to carry out an inspection.
- 27.4 If it is confirmed that a Category 1 hazard exists, the housing authority have a duty to take one of a number of possible enforcement actions. (However, the local authority cannot take enforcement action against itself.) Enforcement actions include the serving of various forms of notice, which may require the person on whom the notice is served to take remedial action, or may prohibit the use of the building or part of the building. In the case of serious risk, the housing authority may, itself, take emergency remedial action.

27.5 In the case of Category 2 hazards, a local authority has discretion to issue the notices described above. However, for these hazards, there is no power to take emergency remedial action.

27.6 A person on whom a notice is served has the right of appeal to the Residential Property Tribunal.

28. Regulatory Reform (Fire Safety) Order 2005

28.1 The Regulatory Reform (Fire Safety) Order 2005 (the 'FSO') does not apply to individual flats, but does apply to the common parts of blocks of flats. The FSO also applies to workplaces within a block of flats. For example, these can include a room used by a caretaker or concierge, a plant room or commercial premises, such as a hairdressing salon in sheltered housing.

28.2 The FSO imposes requirements and duties on the 'responsible person'. In the case of a block of flats, the responsible person is the person having control of the premises. However, if any part of the block is a workplace, the responsible person in that workplace is the person who employs people to work there. Commonly, the responsible person is, therefore, not a named individual, but a company or organisation.

28.3 Typically, the responsible person is the freeholder or landlord, but may be a 'residential management company' (RMCo) or a 'right to manage company' (RTMCo). However, responsibilities and duties imposed on the responsible person also apply to any other person having control of the premises. This includes anyone who, "under a tenancy or contract, has a responsibility for maintenance or repair of the premises, maintenance or repair of anything in or on the premises, or for the safety of the premises". This can include a wide variety of people, including fire risk assessors.

28.4 Managing agents will normally be either a responsible person or another person having control of the premises. The same responsibilities and duties are imposed on the managing agent in each case.

28.5 Other than any part of the block that is a workplace, the responsibilities and duties imposed are limited to matters over which the person has control. Sometimes, flat entrance doors may be outside the control of a freeholder. For example, often, under each resident's lease, the door is legally part of the demised premises and so responsibility for maintenance of the flat entrance door rests with the resident. The landlord has no legal right to force a tenant to upgrade the door to the current standard, nor to carry out the works unilaterally. However, in case of impasse, a landlord should refer the matter to the relevant enforcing authority.

- 28.6 The other persons having control of premises can include contractors who carry out maintenance of fire safety measures. If maintenance is not carried out properly, an offence may be committed by the maintenance contractor.
- 28.7 The FSO imposes a general duty of fire safety care in respect of 'relevant persons'. This includes anyone lawfully on the premises. The duty is primarily to ensure that the fire safety measures within the common parts, plant rooms, and so forth are such as may reasonably be required in the circumstances of the case to ensure that the premises are safe. (If any part of the block is a workplace, the fire safety measures must, so far as is reasonably practicable, ensure the safety of the employees.)
- 28.8 The fire safety measures within the common parts, that must be adequate for compliance with the FSO, comprise the following.
- Measures to reduce the risk of fire and the risk of spread of fire.
 - The means of escape from fire.
 - The measures necessary to assist people in the use of the escape routes, such as emergency escape lighting, fire exit signs and measures for smoke control. (Some of these measures may not be necessary in all buildings: for example, where escape routes are straightforward, easily identifiable and likely to be well-known to occupants, fire exit signs will normally be unnecessary.)
 - Where necessary, fire extinguishing appliances. (These are not normally necessary within common parts, but might be necessary within a plant room, caretaker's office or other non-domestic parts of the block.)
 - Any fire alarm system necessary to ensure the safety of occupants. (Normally, a fire alarm system within the common parts is not necessary or appropriate.)
 - An emergency plan. (In a small block of flats, this may be as simple as a fire action notice, but it is important that the procedure to adopt in the event of fire is disseminated to all residents.)
 - Maintenance of all of the above measures.
 - Maintenance of measures required by legislation (including the Building Regulations) for the safety of, or use by, fire-fighters.
- 28.9 The FSO requires that the appropriate fire safety measures are determined by means of a fire risk assessment. The fire risk assessment must be 'suitable and sufficient' to ensure that the general duty of fire safety care is satisfied within the common parts. This fire risk assessment does not address the safety of residents from fire within their own flat.

- 28.10 If the responsible person or person having control of the premises employs five or more persons in their organisation (regardless of where they are employed), the significant findings of the fire risk assessment must be documented. In this case, the fire safety arrangements must also be recorded. This is part of the requirement to have in place arrangements for the “effective planning, organisation, control, monitoring and review of the preventive and protective measures”.
- 28.11 The FSO is normally enforced by the fire and rescue authority, who carry out inspections to audit compliance with the order. If the fire and rescue authority identify a breach of the FSO, they will notify the responsible person, and may issue an enforcement notice requiring that steps be taken to remedy the breach. In the case of serious risk, a prohibition notice, prohibiting or restricting the use of the premises, may be issued.
- 28.12 A person on whom a notice is served has the right of appeal to the Magistrates’ Court for 21 days after service of the notice. Alternatively, if the responsible person and the fire and rescue authority cannot agree on the measures necessary to remedy a breach of the FSO, the two parties may agree to refer the matter for a determination by the Secretary of State. The Secretary of State’s decision is binding on the fire and rescue authority.
- 28.13 Failure to provide adequate fire safety measures is an offence if the failure places one or more persons at risk of death or serious injury in case of fire. Each such offence is punishable by a fine (currently of up to £5,000) in the Magistrates’ Court, or by an unlimited fine and/or two years imprisonment in the Crown Court.

29. Overlap of legislation

- 29.1 It is obvious from the above that there is overlap between the Housing Act and the FSO. The Housing Act applies to the common parts and the flats themselves, while the common parts also fall within the scope of the FSO. A further complexity is that the safety of the common parts from fire can sometimes rely on fire safety measures within the flats, into which there is no power of entry by the fire and rescue authority, or power to make requirements under the FSO. However, there is such a power under the Housing Act.
- 29.2 Common examples of the influence of fire safety measures within flats on the fire safety of the common parts include the following.

Front doors

The flat entrance doors are critical to the safety of the common parts in the event of a fire within a flat. The doors must be self-closing and afford an adequate degree of fire resistance. Where these doors are, under tenancy agreements, the responsibility of the

freeholder, the FSO and the Housing Act may both be used to address deficiencies, but, in many cases, it will be the FSO that is more appropriate to apply.

In the case of many existing leasehold flats, the responsibility for maintenance of the flat entrance doors rests with the residents. In this case, the freeholder's power to arrange for defects to be rectified may be limited or non-existent, making enforcement action on the freeholder inappropriate.

Under these circumstances, the residents might be regarded as other persons having control of premises (as defined by Article 5(3) of the FSO), with a duty to ensure the adequacy of the flat entrance doors. However, use of powers under the Housing Act may be a more appropriate and better defined route to achieving compliance with the FSO. In new leases, ideally the freeholder should retain control over all flat entrance doors.

Internal doors

To protect the common parts from a fire within a flat, reliance is sometimes placed on internal fire doors within every flat (see Part F of this guide). In determining compliance with the FSO, it may be necessary to establish whether these doors are present. Reliance may need to be placed on the powers of the Housing Act to address this issue.

Ventilation systems

Common kitchen or bathroom extract arrangements can be a route for fire-spread between flats. A 'stay put' policy may be compromised by inadequate measures to prevent spread of fire via a common extract duct. Again, while it may be argued that some powers to address such deficiencies might exist under the FSO, there is no doubt that the powers of the Housing Act can be used for this purpose.

- 29.3 A protocol has been developed that sets out an interrelationship between local housing authorities and fire and rescue authorities with regard to which enforcing authority takes the lead enforcement role in different properties, including purpose-built flats. The protocol describes the manner in which the two enforcing authorities can work collaboratively to discharge their legislative powers under the Housing Act and the FSO in respect of fire safety. The protocol, to which many local housing authorities and fire and rescue authorities have signed up, allows the application of common fire safety standards and describes which body takes the lead in different circumstances. Under the Protocol, arrangements are put in place for consultation and communication between the local housing authority and the fire and rescue authority, so that unnecessary duplication is avoided and one authority can take the lead in any given case.

Part D: Fire risk assessment

Key points

- A fire risk assessment is required by legislation. Its purpose is to evaluate the risk to people from fire.
- It enables the responsible person to determine the necessary fire safety measures required.
- It is normally only necessary to consider the common parts to satisfy the FSO.
- Where a landlord has concern regarding risk to residents within their flats, the fire risk assessment may extend to the flats themselves.
- Intrusive fire risk assessments (involving destructive exposure) will only be necessary where there is justifiable concern regarding structural fire precautions.
- A fire risk assessment need not always be carried out by specialists, but where external specialists are used, care should be taken to ensure their competence.
- Fire risk assessments should be reviewed regularly and when circumstances change.

30. Introduction

- 30.1 A fire risk assessment is the foundation for the fire safety measures required in a block of flats.
- 30.2 A suitable and sufficient fire risk assessment carried out by, or on behalf of, the responsible person will help to ensure that the chance of fire occurring in the areas under the control of the responsible person is minimised. It also helps to ensure that, in the event of a fire anywhere in the block, people can, if necessary, use the common parts safely to evacuate the building. The fire risk assessment will also ensure that appropriate managerial arrangements, such as fire procedures and maintenance of fire safety measures, are in place.

31. Requirement for a fire risk assessment

- 31.1 A fire risk assessment is required by the Regulatory Reform (Fire Safety) Order 2005 (see Part C of this guide).
- 31.2 The fire and rescue authority will examine the fire risk assessment at the time of any audit of the building. They do not carry out the fire risk assessment, but may give a certain amount of advice to the responsible person. The fire risk assessment should not be confused with an assessment carried out by the local housing authority for the purpose of the Housing Health and Safety Rating System.

32. What is a fire risk assessment?

- 32.1 Fire risk is a combination of the likelihood of fire occurring and the consequences to the safety of people if it does occur. A fire risk assessment is, therefore, simply a systematic and structured examination of the likelihood of fire and the likely consequences to residents and others who may be affected by a fire.
- 32.2 The purpose of a fire risk assessment is to evaluate the risk to people from fire, taking into account existing fire safety measures, and to determine whether additional measures are necessary.

33. Common misconceptions about fire risk assessments

- 33.1 There is often confusion regarding what is meant by the term 'fire risk assessment'. There is also different opinion over the exact scope of a fire risk assessment, particularly one required by the FSO. Landlords and other responsible persons are also frequently uncertain as to the extent to which existing fire safety measures – particularly relating to the structure of the building – need to be investigated.

33.2 Accordingly, to avoid some common misconceptions, the following points should be noted.

- A fire risk assessment is not carried out at the design stage of a building.
- A fire risk assessment is not a building snagging exercise, carried out just prior to occupation; it can only be completed after the building is in use.
- A fire risk assessment need not always be carried out by specialists, such as consultants. Use of this guide might enable the responsible person to carry out their own fire risk assessment, particularly in small, simple blocks of flats.
- Normally, fire risk assessments need not involve destructive inspection of the building, such as opening up of construction. However, where practicable, it may be appropriate to lift a sample of accessible false ceiling tiles, or to open a sample of service risers.
- Although the scope of a fire risk assessment is limited to the common parts, it is essential that the fire resistance between the flats and the common parts is considered. In particular, it will be necessary to examine at least a sample of flat entrance doors to ensure that they are fire-resisting and self-closing. Care should be taken to look out for other obvious ready routes where fire might spread between the flats and the common parts, such as meter or milk delivery cupboards, windows, and so forth.
- A fire risk assessment is not an exercise to identify failings in workmanship and materials at the time a new building is handed over. It is equally not intended to identify all latent defects in existing buildings. It is undoubtedly the case that a fire may reveal hidden shortcomings that could not reasonably be identified by a fire risk assessment.
- Simply because the FSO requires that, where necessary, certain fire safety measures are required, it does not mean that such measures are necessary in all cases. For example, the FSO requires that, where necessary, all premises to which the Order applies have adequate fire extinguishers and fire alarm systems. In a purpose-built block of flats, these measures are not normally necessary in the common parts.
- It is not sufficient for a fire risk assessment to consider only the measures needed to assist residents to escape from fire. For example, measures to prevent a fire within the common parts must be considered, as must the maintenance of any measures that were required under Building Regulations for the safety of, or use by, the fire and rescue service.
- Although the FSO only applies to the common parts, residents within flats are 'relevant persons', whose safety from a fire that starts in or spreads to the common parts, must be considered.

34. Scope of a fire risk assessment

34.1 As the fire risk assessment is concerned with fire safety within the common parts, the flats themselves are outside the scope of the FSO. Accordingly, the scope of the fire risk assessment required by the FSO does not include measures to protect residents from a fire in their own flat. However, it will normally be necessary to gain limited entry to at least a sample of flats. This is to examine the necessary measures to ensure when a fire occurs in a flat, that there is not undue risk to other residents.

34.2 The relevant fire safety measures and managerial arrangements that must be considered in a fire risk assessment are, in effect, the fire safety duties set out in Articles 10-22 of the FSO.

34.3 In summary, the fire risk assessment must consider the 'general fire precautions' defined in the FSO. Of these, the principal ones for a purpose-built block of flats are:

- measures to reduce the risk of fire and the risk of the spread of fire
- means of escape from fire
- measures to ensure that escape routes can be safely and effectively used
- an emergency plan, including procedures for residents in the event of fire
- measures to mitigate the effects of fire.

34.4 'General fire precautions' also include fire extinguishing equipment and fire alarm systems. While these are not normally necessary, if such measures are present, consideration needs to be given as to whether they are appropriate or whether they are, in fact, undesirable.

34.5 The fire risk assessment must also consider the maintenance arrangements for all measures required under the FSO or, in the case of equipment and facilities for the fire and rescue service, under Building Regulations.

35. Types of fire risk assessment

35.1 The scope of a fire risk assessment needs to be relevant to the nature of the premises and the amount known in respect of the structural protection. There are, in principle, four different types of fire risk assessment that can be carried out for a purpose-built block of flats. They differ in the extent to which the building is inspected.

Type 1 – Common parts only (non-destructive)

A Type 1 fire risk assessment is the basic fire risk assessment required for the purpose of satisfying the FSO.

The inspection of the building is non-destructive. But, as well as considering the arrangements for means of escape and so forth, the fire risk assessment includes examination of at least a sample of flat entrance doors. It also considers, so far as reasonably practicable, the separating construction between the flats and the common parts without any opening up of construction. However, in this Type of fire risk assessment, entry to flats beyond the area of the flat entrance door, is not involved.

Where there are demountable false ceilings in the common parts, it may be appropriate to lift a sample of readily accessible false ceiling tiles. In addition, it will normally be appropriate to open a sample of service risers, provided access is practicable at the time of inspection.

Unless there is reason to expect serious deficiencies in structural fire protection – such as inadequate compartmentation, or poor fire stopping – a Type 1 inspection will normally be sufficient for most blocks of purpose-built flats. Where doubt exists in relation to these matters, the action plan of a Type 1 fire risk assessment may recommend that one of the other types of fire risk assessment be carried out or that further investigation be carried out by specialists. (However, this should not be a generic recommendation of all Type 1 fire risk assessments; the recommendation should be based on identification of issues that justify reason for doubt.)

Type 2 – Common parts only (destructive)

The scope and objectives of a Type 2 fire risk assessment are generally similar to those of a Type 1 fire risk assessment, except that there is a degree of destructive inspection, carried out on a sampling basis. This will usually necessitate the presence of a contractor for the purpose of opening up construction and making good after the inspection.

In order to check the integrity of separating construction, the areas in which destructive inspection is carried out might sometimes include a sample of flats. However, because of the nature of the work, this can often only be carried out in vacant flats.

A Type 2 fire risk assessment is usually a one-off exercise, which is carried out only if there is good reason to suspect serious structural deficiencies that could lead to spread of fire beyond the flat of fire origin. The age of the block alone is not generally sufficient to warrant a Type 2 inspection. The need for a Type 2 fire risk assessment may sometimes be identified in a Type 1 fire risk assessment, but should not simply be recommended as a matter of course.

Type 3 – Common parts and flats (non-destructive)

A Type 3 fire risk assessment includes the work involved in a Type 1 fire risk assessment, but goes beyond the scope of the FSO (though not the scope of the Housing Act). This risk assessment considers the arrangements for means of escape and fire detection (ie smoke alarms) within at least a sample of the flats. Within the flats, the inspection is non-destructive, but the fire resistance of doors to rooms is considered.

Measures to prevent fire are not considered unless (eg in the case of maintenance of the electrical and heating installations) the measures are within the control of, for example, the landlord.

A Type 3 fire risk assessment may sometimes be appropriate for rented flats if there is reason to suspect serious risk to residents in the event of a fire in their flats. (This might be, for example, because of the age of the block or reason for suspicion of widespread, unauthorised material alterations). This type of fire risk assessment will not be possible in the case of long leasehold flats, as there is normally no right of access for freeholders.

Type 4 – Common parts and flats (destructive)

A Type 4 fire risk assessment has the same scope of work as a Type 3 fire risk assessment, except that there is a degree of destructive inspection, in both the common parts and the flats, carried out on a sampling basis. This will usually necessitate the presence of a contractor for the purpose of opening up construction and making good after the inspection. However, the nature of the work is such that, often, destructive inspection within flats can only be carried out in those that are vacant.

This is the most comprehensive fire risk assessment, but will only be appropriate in limited circumstances – such as when a new landlord takes over a block of flats in which the history of works carried out is unknown and there is reason to suspect serious risk to residents from both a fire in their own flats and a fire in neighbours' flats.

Note: Before destructive inspection is to be carried out, the risk of disturbing asbestos should be considered (eg by examination of the asbestos register).

36. The risk assessment process

36.1 There is no single right or wrong way of carrying out a fire risk assessment. The important issue is that the scope is appropriate and that the relevant fire safety measures are properly examined. Traditionally, guidance has referred to the 'five steps' to risk assessment. This is the approach outlined in the HM Government guide 'Fire safety risk assessment: sleeping accommodation' (see Appendix 2).

- 36.2 More detailed guidance on the steps involved in carrying out a fire risk assessment are set out in the British Standards Institution publicly available specification, PAS 79 ('Fire risk assessment: guidance and a recommended methodology'). PAS 79 sets out nine separate steps in the fire risk assessment process (see Appendix 2). However, it is stressed that many other approaches are equally acceptable.
- 36.3 If the responsible person employs five or more people in the organisation (regardless of where they are employed to work), the significant findings of the fire risk assessment must be documented. (Under certain circumstances, this can be required where less than five persons are employed.)
- 36.4 The minimum information that must be recorded in the above circumstances comprises:
- the measures that have been taken, or are in place, to satisfy the FSO
 - the measures that will be taken to achieve compliance (the action plan)
 - any group of persons identified by the fire risk assessment as especially at risk.
- 36.5 There is no legal requirement to use any particular style or format for recording the findings of a fire risk assessment. (DCLG guidance and PAS 79 contain templates that can be used, but are simply examples, and other formats can be equally acceptable.)

37. The action plan

- 37.1 The outcome of the fire risk assessment should be a suitable action plan. The action plan should set out a list of any (normally prioritised) physical and managerial measures that are necessary to ensure that fire risk is maintained at, or reduced to, an acceptable level. Prioritisation should be commensurate with the risk, but it is important to acknowledge that major capital work cannot be completed immediately. Recommended timescales must be realistic.
- 37.2 In formulating an action plan, the following questions should be considered.
- Will the plan, once implemented, achieve adequate safety for people?
 - Will any hazards to health and safety be created?
 - Are the actions reasonably practicable, taking cost, effort and risk into account?
 - What will the view of residents be if the actions are implemented?
 - Will it be practicable to maintain the precautions in place during normal use of the building?
 - Do the proposed actions have any implications for accessibility and safety of disabled people?

38. Who should carry out the fire risk assessment?

- 38.1 There is no legal requirement for the fire risk assessment to be carried out by specialists, such as consultants. Indeed, in the case of, say, small or modern blocks of flats (eg built within the last 20 years), it can be advantageous for the landlord or other responsible person to use this guide and carry out the fire risk assessment themselves. Their consequent understanding of the fire safety design in the building will enable them to manage fire safety better on an ongoing basis.
- 38.2 In the case of taller blocks of flats (eg comprising more than a ground and three upper storeys), more specialist knowledge may be necessary to carry out a fire risk assessment, particularly if the block was designed and constructed before 1992. However, the decision as to whether to use outside specialists to carry out a fire risk assessment rests with the responsible person.
- 38.3 Regardless of who carries it out, the Responsible person will be liable to prosecution if, as a result of an inadequate fire risk assessment, people are placed at the risk of death or serious injury in case of fire. Equally, anyone carrying out the fire risk assessment for the responsible person has the same liability. Nevertheless, external services can only be advisory in nature and there will still be a need for some involvement of the responsible person in the fire risk assessment process – even if only to provide certain information and arrange access.

39. Competence of professional fire risk assessors

- 39.1 Commonly, freeholders, landlords and managing agents prefer to use the services of external specialists ('fire risk assessors') to carry out their fire risk assessment. In this case, it is essential that the competence of the fire risk assessor is ensured. This is because, as discussed above, the legal responsibility for the adequacy of the fire risk assessment cannot be delegated.
- 39.2 Guidance on selecting a suitable professional fire risk assessor is given in Appendix 3 to this guide.

40. Review of fire risk assessments

40.1 The fire risk assessment is a living document, which cannot remain valid for an unlimited length of time. It needs to be reviewed periodically.

40.2 For compliance with the FSO, fire risk assessments need to be reviewed:

- regularly (see below)
- when material alterations take place
- when there is a significant change in the matters that were taken into account as the risk assessment was carried out – this includes a widespread change in the type of residents occupying the block
- when there is a reason to suspect that the original fire risk assessment is no longer valid (eg after a fire that occurred within, or spread to, the common parts)
- after completion of significant works completed to address shortcomings identified by the fire risk assessment.

40.3 Review of a fire risk assessment is not necessarily the same as a repeat of the entire fire risk assessment process. If a thorough fire risk assessment has been carried out, a shorter review exercise might be carried out regularly, with a more fundamental new fire risk assessment completed at less regular intervals.

40.4 The frequency with which fire risk assessments should be reviewed in the absence of any known changes is not defined in the FSO. The date by which a fire risk assessment should be reviewed should be determined as part of the process of carrying out a fire risk assessment.

40.5 The frequency of review should take into account the rate with which changes, including those arising from the need for maintenance work, are likely to occur, and the risk to people that might arise from changes. This means that a less frequent review might be acceptable if there is close management control of the common parts, including frequent routine inspections.

40.6 As a general guide, for a low risk, modern, low-rise block (eg a block of no more than three storeys above ground, built within the last 20 years), a review every two years might be sufficient, with a new fire risk assessment completed every four years. For blocks with higher risk – arising from social factors, the age of the building, and so forth – and blocks over four storeys in height, an annual review might be more appropriate, with a new fire risk assessment every three years. In extreme cases, for the highest risk premises, an annual fire risk assessment might be appropriate.

40.7 Even if outside specialists carry out the fire risk assessments, it is possible that reviews could be carried out by those with less specialist knowledge, such as in-house staff who have received suitable training, as the review concentrates primarily on progress with the previous action plan and identification of changes.

When commissioning a fire risk assessment from external specialists, landlords and other responsible persons should:

- specify what type of fire risk assessment is required – remember Type 1 will often suffice and other types involve extra time, cost and disruption that may not be justified unless there is good reason to suspect serious deficiencies in fire safety
- ensure you provide the fire risk assessor with relevant information on the building, the occupants and arrangements for management of fire safety
- recognise that all risk assessments will involve a degree of access to a sample of flats – you will need to assist in arranging access
- where you specify a risk assessment requiring destructive surveys, expect to employ a contractor to open up the construction – rarely do third party fire risk assessors have in-house resources to carry this out
- recognise that no risk assessment can be exhaustive – expect recommendations for further investigation if there is difficulty in establishing, for example, the suitability of floors and walls to resist fire-spread – however, challenge generic recommendations which are not supported by justified concern that serious deficiencies are present, taking into account all relevant sections of this guidance
- consider specifying the style and format you require for the fire risk assessment reports – consider adopting recognised templates, such as those in PAS 79 or the HM Government guide ‘Fire safety risk assessment: sleeping accommodation’.
- insist that action plans include a clear priority and timescale for all recommendations and differentiate between those recommendations essential to satisfy legislation and those that are a matter of good practice
- remember that using an external specialist does not absolve you of your responsibilities under the FSO
- ensure your fire risk assessor is competent
- establish that your fire risk assessor has suitable experience and knowledge of carrying out fire risk assessments in the type of buildings within your housing stock.

Part E: Managing fire risk – preventing fires

Key points

- Prevention of fire, as far as possible, is essential.
- The most likely place for fire to start is within a flat. However, fires within the common parts are particularly dangerous.
- There should be vigilance to ensure that people do not smoke in the common parts.
- Arson is a common cause of fire, so good security is part of fire prevention.
- Poor housekeeping in the common parts is a significant fire hazard.
- There should be a clear policy on whether common parts must remain completely sterile ('zero tolerance') or may be subject to 'managed use'.
- Fixed electrical installations should be subject to periodic inspection and test every five years in the case of the common parts, and every ten years for the installations in flats.
- Heating and ventilation systems should be maintained regularly, particularly where they serve the common parts or are common to more than one flat.
- Any lightning protection systems should be subject to regular maintenance.

41. Introduction

- 41.1 The importance of preventing fires cannot be overstated. This is a key consideration in a fire risk assessment. It is also fundamental to good fire safety management.
- 41.2 This part of the guide is aimed primarily at giving guidance on fire prevention within the common parts of blocks of flats. However, the most likely place for a fire to start within a block of flats is the flats themselves. It is recognised that the scope for landlords to take steps to prevent fires within flats is limited. Nevertheless, there are opportunities in rented flats through, for example, regular gas safety checks and periodic inspections of electrical installations to impact on the potential for certain fires within flats.
- 41.3 It is strongly recommended that landlords and those managing blocks of flats take every suitable opportunity to engage with, and educate, residents on basic fire prevention. This is discussed further in Part G of this guide.
- 41.4 Common hazards and possible measures to control or eliminate them are set out below. However, a guide such as this cannot be exhaustive, and landlords and those managing fire safety must be vigilant for other hazards that might be present or new hazards that might materialise in the future.

42. Smoking

42.1 By law, smoking is not allowed in the common parts of blocks of flats. There still exists the very real need to remain vigilant, not only because of people inadvertently smoking in areas where the law prohibits it, but also because of illicit and surreptitious smoking. Indeed, with regard to smoking, people's efforts to conceal their actions, can often result in increased risk.

42.2 Residents need to be reminded that the law on smoking applies to the common parts. 'No smoking' signage is a statutory obligation, but taking other simple, basic steps can help. These can include providing suitable receptacles for smokers' materials outside entrances to encourage people to put out their cigarettes before entering.



42.3 Residents' handbooks, fire safety leaflets and other communications with residents provide opportunities to inform and educate on this basic, but vital, message.

When inspecting the block, use the opportunity to:

- look out for evidence of smoking in the common parts
- check that 'no smoking' signs are still in place
- make sure receptacles provided for disposal of smokers' materials are being emptied on a regular basis.

43. Arson

43.1 In 2008, deliberate ignition was the cause of some 17 per cent of fires in dwellings – the third largest cause of fires in dwellings. These fires resulted in 59 deaths and nearly 1,600 non-fatal casualties⁶. Security is therefore a key element of fire prevention in blocks of flats.

43.2 The nature of deliberate fires experienced in blocks of flats varies, but can range from people setting fire to rubbish and storage left within the common parts to igniting flammable liquid poured through letter boxes of front doors. The profile of those carrying out such acts clearly varies. Anti-social behaviour can be a factor in accounting for some of these fires. Basic security can often be very effective in countering these fires.

43.3 However, it must be recognised that some fires are started by those with the deliberate intent of causing serious harm to people. It is unlikely to be practical to implement physical measures completely to counter this risk. Vigilance by residents, along with visiting staff and contractors, will continue to be key to any programme of arson prevention.

Measures that can be used to address the potential for arson include:

- good physical security, with suitable locks on doors and windows in common parts
- where appropriate, access control linked to entry-phones in flats
- effective lighting, both externally and internally, in the common parts
- where appropriate, CCTV, particularly on entrances and external façades
- maintaining common areas free from combustible material
- where possible, maintaining a presence by people such as caretakers and concierges
- where appropriate, for communal letterboxes, use of suitable enclosures designed to contain burning material
- supporting initiatives to address anti-social behaviour.

6 Source: UK Fire Statistics 2008



43.4 The possible conflict between security and fire safety must be taken into account. Any measures taken to restrict access must not prevent people escaping easily in a fire.

43.5 Residents should also be encouraged to make their homes secure. Advice on crime prevention in the home is available from

43.6 Residents may take their own measures, including fitting additional locks to front doors and installing intruder alarm systems. Again, care is needed to ensure that any measures taken do not conflict with the need to escape in the event of fire. Where possible, leases should be used to constrain the fitting of excessive security measures, such as grilles, gates and shutters, that might:

- delay escape by the residents
- impinge on the safety of others (eg across a common balcony)
- prevent access to the fire and rescue service to effect rescue and fight a fire in a flat.

Security doors that achieve 30 minutes fire resistance are available. Security doors that can be easily removed by the fire and rescue service in an emergency are also available.

When inspecting blocks of flats:

- check that basic security is being maintained, eg that entrance doors are closing effectively and security lights are working
- be vigilant for signs of anti-social behaviour involving fire setting, both inside the block and outside in the vicinity
- check that doors to residents' store cupboards and garages are kept locked
- make sure that plant rooms and electrical cupboards are locked shut and bin rooms are kept secure
- monitor housekeeping in common areas and ensure that the organisation's policy on the use of common parts is being followed.

44. Housekeeping

44.1 Good housekeeping is fundamental to reducing risk in blocks of flats. Controlling the presence of combustible materials and ignition sources not only reduces the potential for accidental fires to start and develop in the common parts, it also significantly reduces the scope for deliberate fires. It also ensures escape routes are free of obstructions that might hinder the evacuation of people from the building and access for fire-fighters.

44.2 The ignition of combustible material within the common corridors, stairways and landings will give rise to the presence of smoke in escape routes and the possibility of fire-spread into flats. Even if combustible material is



present in a room separated from escape routes, such as a lift motor room, there is still a danger that any resultant fire could eventually threaten the escape of occupants of flats. Indeed, many such rooms have a higher probability of fire inception (eg communal boiler rooms and electrical switch rooms). These should therefore be free of combustible materials for that reason alone.

44.3 There is a tendency for some residents to treat the common areas of blocks of flats as an extension of their own home. As a consequence, it is not unknown to find personal belongings being stored in corridors and on stairway landings, along with furniture and electrical appliances.



44.4 Sometimes residents see the common parts as communal amenity areas, where, for example, they can store bicycles, dry clothes and sit on furniture. Some landlords encourage this, particularly in sheltered schemes, in an effort to avoid the block having the appearance of an institution. The presence of, for example, door mats, pot plants, pictures and seating is seen as part of making the block homely for the residents.



44.5 However, many landlords battle with problems that can arise from this, particularly of residents taking matters to extremes (eg holding barbecues on access decks and escape balconies). A further problem is one of abuse, such as dumping unwanted belongings and rubbish in the common parts. Not only can this result in people potentially putting their own lives at risk, it could also endanger the lives of others.

44.6 The inappropriate actions of residents in this regard could also be exposing landlords and others who manage the common parts to liability under fire safety law.

44.7 The nature of items found in the common parts of blocks of flats can vary widely, but have been known to include:

- rubbish bags
- wheeled bins
- buggies and prams
- mobility scooters, bicycles and motor cycles
- lockers and cabinets
- washing machines, tumble dryers and other goods awaiting disposal
- unwanted bedding and mattresses
- upholstered seating
- children's toys and play furniture
- shopping trolleys.



- 44.8 The actual potential for significant smoke production and fire development when combustible materials are ignited varies enormously, depending on the inherent properties of the material. This includes its ease of ignition, the quantity present and its configuration. Not all of the items commonly found are either easily ignitable or likely to give rise to a serious risk if ignited in isolation.
- 44.9 This suggests that it might be possible to allow some items to be present without unduly exposing residents to risk. However, the difficulties landlords and others responsible for the common parts face is how to manage use of the building in this way.
- 44.10 Unrestricted use of common parts is clearly not acceptable. It will, therefore, be necessary to adopt one of the following alternatives:
- i. 'zero tolerance'
 - ii. 'managed use'
- 44.11 A 'zero tolerance' approach is one in which residents are not permitted to use the common parts to store or dispose of their belongings or rubbish. No exceptions would apply. It would ensure that the common parts are effectively 'sterile' ie free of combustible material, ignition sources and obstructions.
- 44.12 The benefits of this approach are:
- it is the simplest policy to adopt
 - it removes not only the risk from accidental fires, involving items in the common parts, but also denies fuel for the arsonist
 - there is no ambiguity regarding what is allowed and therefore residents know exactly where they stand
 - it is easier for landlords to 'police' when carrying out inspections
 - enforcing authorities usually favour this approach
 - it is simpler to audit by those carrying out fire risk assessments
 - it arguably reduces the liability on landlords.

44.13 There are, however, disadvantages including:

- by not taking into account the specific circumstances, this policy might not be risk proportionate
- it unduly penalises those who could manage their common parts effectively
- it denies residents an opportunity to personalise and improve their living environment.

A 'zero tolerance' policy should:

- be adopted by way of 'default'
- always apply when there is doubt over the ability of residents to apply a 'managed use' policy
- be adopted where flats open directly onto stairways unless 'managed use' is considered acceptable by the fire risk assessment
- always apply where the escape stairway is of combustible construction
- always apply where the building needs to be evacuated immediately ie where the standard of fire protection does not support a 'stay put' policy.

44.14 The alternative is 'managed use'. This approach allows strictly defined use of common parts and limits the items allowed, to control fire load and ease of ignition. It includes strict conditions on where such items can be kept. For example, a 'managed use' policy might permit residents to:

- place pot plants and door mats outside their front doors
- have framed pictures and notice boards on walls
- store bicycles, prams and mobility scooters in places that are out of the way and not likely to cause obstruction.

44.15 This approach also has advantages and disadvantages. The benefits include:

- by making the common areas 'homely', it fosters a sense of pride and value in the block, which can impact positively on anti-social behaviour
- it benefits older and disabled people in particular, by allowing them to store mobility aids at the point of access
- it allows the specific risk factors in the building to be taken into account.

44.16 The disadvantages include:

- it is more difficult to adopt as it requires a clearly defined policy with a list of 'dos and don'ts'

- there is more scope for misunderstanding, requiring more education of, and communication with, residents
- while it might be possible to minimise accidental fires with an appropriate ‘managed use’ policy, deliberate ignition may still be a significant concern
- by allowing valuables to be left on view, it can encourage crime and subsequently increase the risk of deliberate ignition
- it is more difficult for landlords to ‘police’, and for enforcing authorities and fire risk assessors to audit
- it is likely to require more frequent inspections by landlords
- failure to adopt the policy effectively could result in liability for landlords should a situation occur that places residents at risk of serious injury or death in the event of fire.

44.17 The most appropriate approach will depend on the specific circumstances, and whatever approach is taken should be considered within the overall context of the fire safety measures in the building. It should be considered as part of the fire risk assessment for the block. A managed use and its constraints can often be agreed by consultation with residents.

44.18 While it may be easier for landlords to take the ‘zero tolerance’ approach, it should be recognised that residents may be put at significant inconvenience and resort to infringements of the policy through frustration. Consideration of the needs of residents in ways that encourage them to follow the constraints of such an approach can contribute significantly to fire safety. Providing suitable communal storage facilities and, for example, charging rooms for mobility scooters, can greatly assist.

When adopting a ‘managed use’ policy:

- carry out a specific risk assessment taking into account the particular circumstances in the building
- consider whether residents are disposed towards keeping ‘rules’, and avoid ‘managed use’ where this is not the case
- ensure that there are clearly defined ‘do’s and don’ts’ that residents can easily follow
- only apply it where there is a suitable standard of fire protection – particular care should be taken when applying it to situations such as single stairway buildings and ‘dead end’ corridors
- limit it to buildings in which the main elements of structure are made of concrete, brick and other non-combustible materials

- take notice of instances of anti-social behaviour and avoid 'managed use' where there is particular concern regarding the potential for deliberate ignition
- generally only apply it to buildings which have effective security, eg access control
- never allow storage of combustible material – where appropriate, make arrangements for residents to have communal facilities for storage
- never allow items to be left awaiting disposal, not even in chute rooms – even short term presence poses a risk
- only allow basic furniture and not upholstered seating
- never allow motorcycles, mowers and other gardening equipment containing petrol and other fuels
- never allow charging of mobility scooters, batteries or other electrical equipment in common parts – consider providing dedicated rooms for charging, suitably fire separated from the rest of the block
- if storage cabinets are appropriate, only permit lockable metal cabinets to be used and never timber or plastic sheds or lockers
- never allow residents to store hazardous chemicals, gas containers or flammable liquids in storage cabinets or dedicated storerooms and cupboards
- only allow scooters, bicycles, prams and so forth, if there are suitable areas, that will not pose an obstruction, where they can be kept.

44.19 Regular inspection is a key component of maintaining good housekeeping. Landlords should ensure that every opportunity is taken to monitor the situation in a block and ensure that there is compliance with the policy adopted. This should apply to the common parts, including stairways, lobbies, corridors, escape balconies and chute rooms. It should also apply to plant rooms, landlords' stores, riser cupboards, Tenant and Resident Association (TRA) lounges and facilities and other communal rooms.

45. Recycling

45.1 Recycling initiatives encourage residents to avoid waste and use resources sustainably. However, collection schemes often involve materials being set out in corridors, lobbies and stairways within the common parts, giving rise to a potentially serious fire hazard.

45.2 Bags of clothes for charity and boxes and bags of newspapers and plastic containers represent a significant fire load. The material is in a form in which it can be easily ignited and lead to extensive fire-spread and smoke production.



45.3 The fire safety design, and specifically the smoke control arrangements, in purpose-built blocks of flats are not intended to cope with fires of this size and severity within these areas of the building.

45.4 While only transitory, such material is nevertheless wholly inappropriate. It cannot be considered acceptable even where 'managed use' policies apply. Landlords should put in place alternative arrangements for recycling that do not rely on collection from within the common parts.

46. Electrical hazards

46.1 Fires of electrical origin account for some 17 per cent of all fires in the home, the second largest cause. In 2008, these fires resulted in 28 deaths and around 1,200 injuries⁷.

46.2 Ignition of combustible materials through overheating or arcing can result when faults develop in wiring or in appliances. Such faults are often evident before a fire occurs. Householders can considerably reduce the likelihood of a fire developing by being vigilant when appliances do not work or circuit-breakers keep tripping, and arranging for these faults to receive attention. Residents should also be encouraged to take preventive action by arranging for their electrical installation to be inspected and tested periodically.

⁷ Source: UK Fire Statistics 2008

- 46.3 Landlords should plan to have the electrical installations in their flats inspected and tested regularly. A number of factors should be taken into consideration when deciding upon the frequency of such inspection, including:
- the age of the property and the electrical installation therein
 - the duration of the tenancy
 - the nature of the tenant expected to take possession of the flat.
- 46.4 An interval of 10 years between such inspections would be appropriate for flats where a long term tenancy agreement is in place. An interval of five years might be more appropriate for situations where the tenancy is shorter.
- 46.5 Where tenant turnover is high, the landlord would be well advised to have a thorough visual inspection of the accessible parts of the electrical installations. For example, landlords should look for signs of damage to installed equipment and accessories which have made access to live parts possible or other defects or deterioration which may pose a danger to the next tenants.
- 46.6 The interval between inspection and testing can be extended where no damage has been observed which would make the flat unsafe over a number of inspections. Conversely, the interval should be reduced where the inspector finds evidence of significant damage or deterioration.
- 46.7 Current guidance states that the electrical installations supplying the flats and the common parts of the block should also be subject to periodic inspection and test. This should be undertaken every five years.
- 46.8 Periodic inspection and testing of electrical installations should be undertaken by suitably competent persons eg a third-party certificated electrical contractor or a member of the Electrical Contractors' Association (ECA). The inspection and test, and any necessary remedial work, should be undertaken in accordance with the current Institution of Engineering and Technology (IET) Wiring Regulations (BS 7671) and the recommendations in IET 'Guidance Note 3'. Guidance on periodic inspection reporting is also available from the Electrical Safety Council (ESC) and can be downloaded from the ESC website.
- 46.9 Any portable electrical appliances that might be present in the common parts and other areas under the control of the responsible person should also be subject to inspection and test on a regular basis. Guidance on the nature and frequency of this can be found in the IET Code of Practice for In-Service Inspection and Testing of Electrical Equipment.

46.10 Others – such as TRAs, who occupy parts of blocks of flats that are outside the control of the Responsible person, and cleaners and maintenance contractors who bring portable electrical appliances into the building – should be encouraged to ensure that they have suitable inspection and testing regimes in place.

To reduce the likelihood of an electrical fire:

- be vigilant during inspections for any obvious damage to electrical fittings and equipment within the common parts
- make sure electrical distribution boards are located in secure cupboards or rooms, within which there is no storage or rubbish
- stop residents from connecting wiring from their flats to decorative lights or other equipment in the common parts
- look out for residents using sockets in the common parts to charge their appliances or power equipment within their flats – running extension leads compounds the hazard by compromising the fire separation between the flats and the common parts
- consider installing key-operated socket outlets within common parts to restrict access to cleaners and other legitimate users.

47. Heating and ventilation systems and equipment

47.1 Heating and ventilation systems serving the common parts are often now completely separate from the systems in the flats. However, this has not always been the case. In the past, communal ducted warm air systems have been employed to heat individual flats. It is still not unusual to find common extract systems for bathrooms and, sometimes, kitchens.

47.2 The hazards arising from communal heating and ventilation systems include both a potential for ignition and a route for fire-spread through common ducts and risers. Planned preventive maintenance is the key to minimising the likelihood that, for example:

a central boiler will catch fire

a fire within supply and extract fans or in ductwork will spread smoke and flames through a building.

47.3 Where portable heaters are used – eg in TRA lounges and community rooms – these should be suitable for their intended use and not subject to easily being knocked over or damaged. Portable gas heaters should not be used.

47.4 Residents should also be encouraged to have their heating systems serviced regularly. While landlords are obliged to arrange annual gas safety checks for rented properties, residents of leasehold flats should also be encouraged to have their appliances checked every year.

48. Lightning

48.1 Lightning is a source of ignition in a small proportion of fires. However, the risk depends on factors such as:

- the location of the building
- the building's size and construction
- the proximity of the building to other structures
- the local topography.

A risk assessment tool for determining the need for lightning protection on a block of flats can be found in BS EN 62305-2, but normally needs a specialist to apply it.

48.2 Retrospective installation of lightning protection is rarely likely to be considered essential for compliance with legislation in existing blocks of flats. However, any existing lightning protection systems should be subject to regular inspection and testing. Guidance on this is available in BS EN 62305-3.

49. Other causes

49.1 Although cooking does not occur in the common parts of a block of flats, it is the most common cause of fire in dwellings – some 45 per cent in 2008⁸. It may be necessary to consider cooking hazards where there are communal facilities, such as TRA lounges, and in sheltered schemes where catering is provided. A key component to reducing the risk is regular maintenance and cleaning of cooking appliances and any associated extract systems, especially if deep fat frying is undertaken.

49.2 There are other hazards that might only be present on occasions. Good examples are the hazards associated with building works and contractors operations. This is considered in Part G of this guide.

⁸ Source: UK Fire Statistics 2008

Part F: Managing fire risk – fire protection

Key points

- Benchmarks should be used to assess the standard of fire protection in a block of flats. These are not prescriptive, and the aim should be to use them to determine a reasonable approach to improving fire safety where the fire protection measures have been found to be inadequate.
- Initially, these benchmarks might be those that were in place when the block was built, rather than those that currently apply.
- However, upgrading existing buildings to meet current benchmarks may be appropriate in situations in which the original standards are far removed from what is acceptable today, and, as a result, there is unacceptable risk.
- While the appropriate solution might be to restore what was originally in place, upgrading to achieve current benchmarks should take place when the opportunity arises, such as through the normal process of refurbishment.
- When upgrading fire precautions, fire protection products and services should be fit for purpose and properly installed. Third party certification schemes are available for many such products and services.
- Effective compartmentation is fundamental to ensuring adequate fire safety in blocks of flats. It is therefore vital that floors and walls are in good condition and that there are no openings that would permit uncontrolled spread of fire and smoke.
- Particular attention should be given to the potential for fire-spread through common ventilation ducts.
- Escape routes from flats in some older blocks may involve forms of alternative exit, such as linking balconies and pass doors, that are no longer recommended. Compensatory measures may need to be provided where this is the case.
- Increases in travel distance and other departures from current benchmark design guidance may need to be accepted. Compensatory measures may again be required in some cases.
- Original flat entrance doors in many older blocks will not meet current standards. In some situations, it will be appropriate to accept the door as it is; in others, upgrading or replacement of the doors will be necessary. This will depend on the risk.
- The fitting of suitable self-closing devices to flat entrance doors is an essential short-term measure.

- Fire exit signs will not often be required in blocks of flats, particularly those with a single stairway.
- Emergency escape lighting will be required in all but the smallest of blocks.
- All flats should be provided with smoke alarms installed in accordance with BS 5839-6.
- Where, on rare occasions, fire alarm systems are installed in the common parts, these systems should comply with BS 5839-1. Use of smoke alarms in the common parts is inappropriate.
- Provision of fire extinguishers or hose reels is not normally considered necessary, other than in plant rooms, community facilities, staff rooms and so forth.
- In mixed use buildings, the risks presented by other occupancies, and the way these risks can impact on the safety of the residents of flats, need to be taken into account.
- The limitations of the residents of sheltered housing schemes should be taken into account when determining suitable fire safety measures. However, the principles of a 'stay put' policy apply equally to such schemes.
- Fire-fighting facilities provided in existing blocks of flats should at least meet the standard of the day the block was built and should be maintained in efficient working order.
- Restrictions apply to the nature and construction of external cladding systems and to the materials used for façades. This is in order to limit the potential for external fire-spread, particularly in high-rise blocks.

50. Introduction

- 50.1 This Part of the guide is concerned with the in-built fire safety measures in a block of flats, ie those elements necessary to ensure a satisfactory standard of fire protection. The objectives and principles behind these measures are discussed in Part B of this guide. The aim of these measures is to ensure reasonable safety for those escaping a fire and, where a 'stay put' policy applies, for those remote from the fire while they remain in their flats.
- 50.2 Set out below are benchmarks, against which the standard of safety in a particular block can be assessed, but these should not be seen as prescriptive standards.
- 50.3 Initially, a fire will only present a threat to those in its immediate vicinity. The majority of fires in purpose-built blocks of flats do not spread beyond the location of origin. However, it has also to be assumed there is a small chance that, at some stage, fire might spread to affect other areas of the building, including the common parts and the communal escape routes.

51. Limitations of this guidance

- 51.1 The wide variation in age, design and construction of blocks of flats is such that this guide can only cover the more common designs and more commonly employed fire safety measures found in purpose-built blocks of flats. Inevitably, there will be layouts and circumstances that will not be fully addressed by this guide. However, it is hoped that use of the basic principles outlined below will enable a meaningful assessment to be made of the level of safety in these blocks. Landlords and other responsible persons should be aware that, in these circumstances, it is likely that help will be needed from suitable specialists.

52. Methodology for using benchmarks

- 52.1 When carrying out a fire risk assessment, or otherwise reviewing fire safety design in a block of flats, it is important to compare the standard found in a particular block against appropriate benchmarks. Only then can judgements be made about the adequacy of the fire safety measures.
- 52.2 Initially, these benchmarks might be those that were in place when the block was built and not those that currently apply. Indeed, it is normally inappropriate to retrospectively upgrade existing blocks to meet current benchmarks without justification on the basis of fire risk.
- 52.3 Nevertheless, there may be situations in which the original benchmarks of the day are far removed from what is acceptable today and, as a result, there may be an unacceptable risk.

52.4 The guidance in this part is set out in such a way as to highlight:

- the benchmark standards recommended by current design codes and guides for the design of modern blocks of flats
- the most commonly found differences between newly built blocks and those designed to meet the standards of the day that applied when an existing block was built
- possible solutions that might be suitable where the standard found in an existing building has not been maintained in line with the original design intent, or falls far short of the standard considered acceptable today.

52.5 The following illustrates a framework used when carrying out a fire risk assessment for comparing the standard of fire safety found in a particular block with these benchmarks.

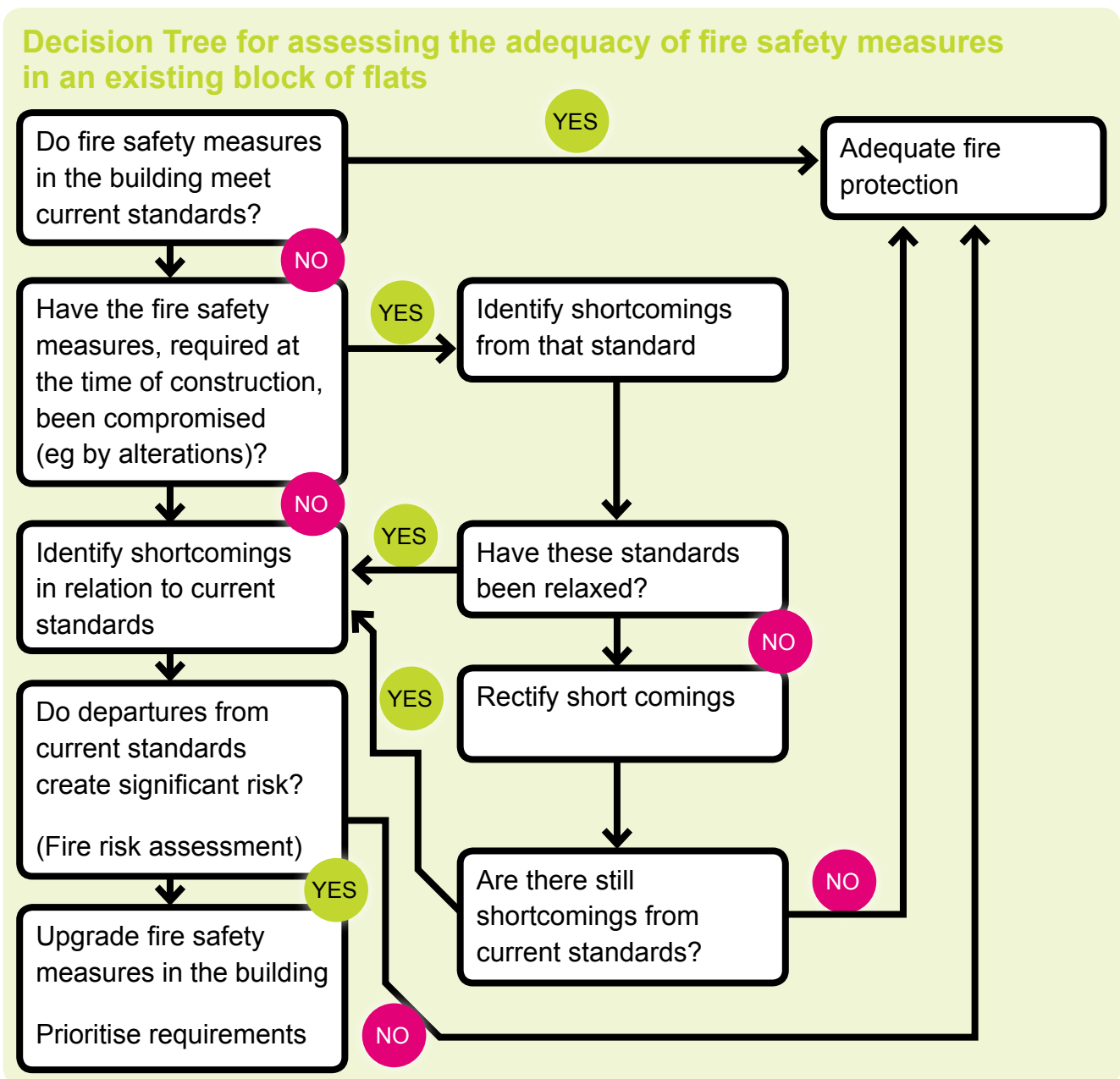

- 52.6 The aim is to determine a reasonable approach to improving fire safety in existing blocks of flats where the existing fire safety measures have been found to be inadequate.
- 52.7 It must be recognised that it will not always be reasonably practicable to achieve solutions that conform to today's standards. The appropriate solution may simply be to restore what was originally there until such time as it can be upgraded through the normal process of refurbishment of the building. The objective is to establish whether the departures from current benchmarks create significant risk and, if they do, to determine a realistic solution that can be implemented within the constraints of an existing building.
- 52.8 An example that illustrates this approach is the replacement of a flat entrance door by a resident with a non-fire-resisting door that is not self-closing. As discussed later, the current benchmark standard is for flat entrance doors to be self-closing doors, capable of providing 30-minute fire resistance and incorporating intumescent strips and smoke seals (FD30S). If the door that had been replaced was in a block dating from, say, the 1960s, it is most likely that the original door would be fire-resisting, but might only be fitted with rising butt hinges. It would not incorporate intumescent strips and smoke seals.
- 52.9 In the situation described above, the replacement door does not meet current benchmark standards. It also does not meet the standards of the day the block was built. Those standards have not been relaxed. The new door, if replaced with a door similar to the one originally fitted, would still not meet current standards. As explained later, the lack of a positive action self-closing device at the very least is considered to create significant risk. In practice, replacement of the new door with an FD30S door, fitted with a positive action self-closing device, would be the appropriate solution.
- 52.10 As another example, it is frequently found that residents have also removed original self-closing devices from internal doors within flats, which were required by the standards of the day. However, these self-closing devices are not now required for compliance with current Building Regulations. Accordingly, under most circumstances, they are no longer necessary within existing flats (see paragraph 56.23).
- 52.11 Other examples of the application of this approach and the guidance that follows below are contained in Appendices 7–12.
- 52.12 Appendix 1 contains a history of fire safety design standards for purpose-built blocks of flats. It is therefore, a reference source for determining the standard that applied when a particular block was built.

53. Third-party certification

- 53.1 When upgrading fire precautions, fire protection products and related services should be fit for their purpose and properly installed and maintained in accordance with the manufacturer's instructions or a relevant standard.
- 53.2 Third-party certification schemes for fire protection products and related services are an effective means of providing the fullest possible assurances, offering a level of quality, reliability and safety that non-certificated products may lack. This does not mean goods and services that are not third-party approved are less reliable, but there is no obvious way in which this can be demonstrated.
- 53.3 Third-party quality assurance can offer comfort, both as a means of satisfying you that goods and services you have purchased are fit for purpose, and as a means of demonstrating that you have complied with the law.

54. Compartmentation

- 54.1 Adequate compartmentation is a basic requirement in all purpose-built blocks of flats. The standard of fire separation, whether between individual flats, between flats and the common parts, or between the common parts and ancillary accommodation, such as refuse chutes and plant rooms, should be a key consideration when undertaking a fire risk assessment.
- 54.2 The standard of compartmentation and fire separation recommended in design guides for blocks of flats has changed over the years, particularly in comparison to those published prior to the 1960s. This has inevitably led to variations, both in the nature of the construction and in the periods of fire resistance that can be found in existing blocks of flats.
- 54.3 Current benchmark design guidance for new purpose-built blocks of flats recommends that the following should be constructed as compartment walls and floors:
- every floor (unless it is within a multi-level flat)
 - every wall separating a flat from any other part of the building
 - every wall and floor enclosing a refuse storage room.
- 54.4 The current minimum level of fire resistance is 60 minutes (higher in the case of high-rise blocks, but normally 30 minutes in small, two-storey blocks of flats). Previous design standards for older, traditionally built blocks of flats, with timber floors, permitted a lower level of fire resistance, typically 30 minutes.
- 54.5 In practice, the materials that were used, and the method of construction adopted, in older blocks of flats, might not achieve these periods of fire resistance. Traditionally, the combination of a lath and plaster ceiling below a timber floor was only considered

to provide a notional 30 minutes fire resistance. In reality, the performance of lath and plaster is highly variable, given that the thickness of the plaster is not uniform.

Fire resistance of existing compartment walls and floors

54.6 In principle, the potential risk to the occupants of flats increases with the height of the block, the size of the building and the number of flats present. It may, therefore, be reasonable to accept reduced levels of fire resistance for compartment floors and walls in existing small, low-rise blocks. However, this would depend on other inter-related factors, most importantly the provision of adequate means of escape. Benchmark levels are set out below.

As a benchmark, the minimum levels of fire resistance for compartment walls and floors for existing blocks of flats should be:

- three-storey – notional 30 minutes fire resistance – typically timber floors with lath and plaster ceilings.
- four- and five-storey – full 30 minutes fire resistance – typically timber floors with plasterboard ceilings.
- six-storey and above – 60 minutes fire resistance.

54.7 In certain situations, in existing blocks where these periods of fire resistance are not met or cannot readily be achieved by upgrading, compensatory fire protection measures may need to be considered. These measures might include one or more of the following:

- improving the means of escape by providing an alternative escape route or upgrading protection to the enclosure of escape routes to current benchmark design standards, eg FD30S doors
- provision of an automatic fire detection and alarm system to compensate for the reduced levels of fire resistance
- provision of a sprinkler, or other suitable fixed automatic suppression, system.

Existing condition of compartment walls and floors

54.8 It is vital that floors and walls are in good condition and that there are no openings, whether intentional or unintentional, that would permit the uncontrolled spread of fire and smoke. The potential for fire to spread through any service ducts and risers, ventilation ducts and refuse chutes, and by means of openings around gas, electricity, water, drainage and telecommunications services, should be considered.

54.9 Obvious openings between floors, and in walls between flats and other ancillary accommodation (eg plant rooms) and the common parts, should be considered. Particular attention should be paid to service ducts or risers and any common ventilation systems.

54.10 Within flats, consideration will need to be given to the adequacy of fire stopping around any openings in walls and floors for services such as gas, water, electricity, telecommunications and drainage. These may be present where such services enter from the common parts or pass between flats. In most cases, the extent of any openings and the extent of fire stopping can only be ascertained through destructive inspections and by opening up panels in kitchens, bathrooms and other areas. This would only apply when Types 2 and 4 fire risk assessments are carried out.



54.11 Small bore pipes, typically less than 40mm in diameter, are not normally considered to be of concern. Larger pipes, especially if made of a combustible material, could, in a fire, give rise to an opening that will allow significant fire and smoke-spread. Proprietary fire seals, including externally mounted collars, or fire-resisting enclosures, are used in new buildings and could be used to address this problem in older blocks. However, the difficulties of retrofitting such seals in an occupied block of flats may mean that it will only be practicable to undertake this on a long-term basis as and when flats become vacant.



54.12 In addition, in some designs of blocks of flats, use will be made of common ventilation ducts to provide extract from bathrooms and, less commonly, kitchens. These ducts may well travel the full height of the building, serving a large number of flats and terminating at roof level.

54.13 It has been traditional for many years for the common extract from bathrooms to incorporate shunt ducts, which reduce the likelihood of fire and smoke-spread between flats. Some earlier designs used the same arrangement for kitchen extract, although this was not a preferred method.

Figure 1 – Shunt duct arrangements

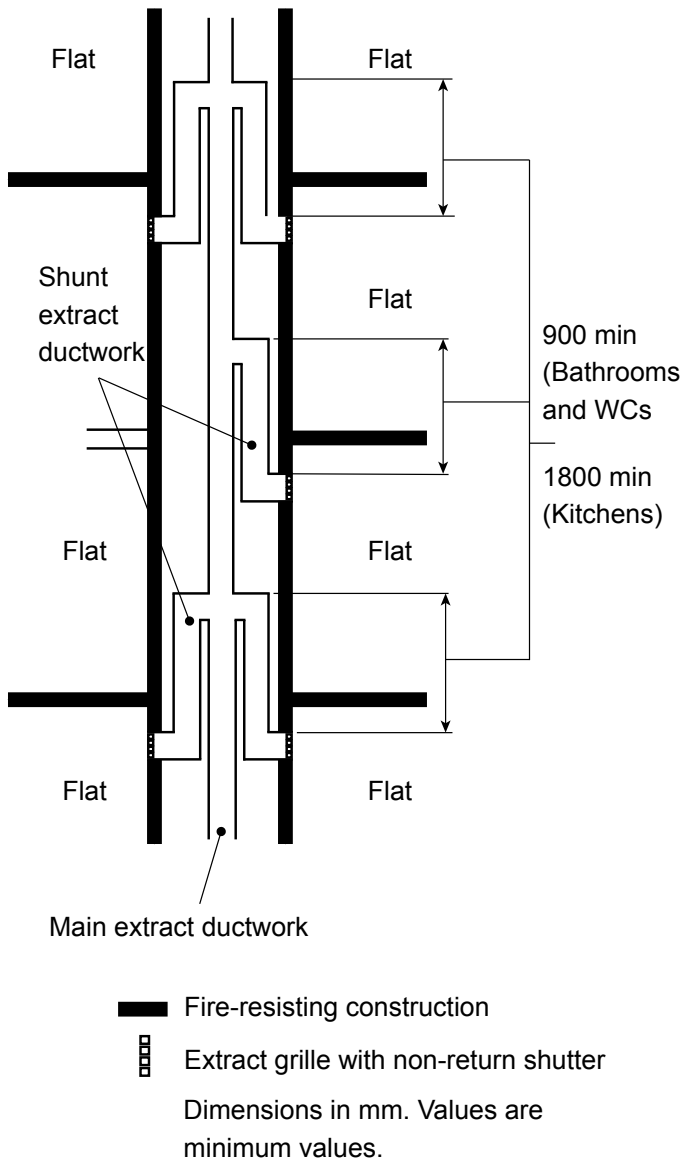

54.14 However, there are blocks of flats that do not incorporate shunt ducts and have no adequate means of preventing fire and smoke-spread between flats via ventilation ducts. The absence of measures to prevent fire and smoke-spread via common ventilation systems is so far removed from what is acceptable today that action will be necessary to reduce the risk it poses.

54.15 In existing flats, it will rarely be practicable to upgrade ventilation systems to meet current benchmark standards and retrospectively introduce mechanical fire and smoke dampers into the ducts. However, one way of reducing the potential for fire-spread between flats would be to fit intumescent fire dampers to the vents into the ducts. Although this would not restrict the spread of smoke in the early stages of a fire, it would prevent spread of flames and hot gases. This is a reasonable approach for bathrooms, but is less satisfactory for kitchens, where there is the potential for a serious fire in the room in which the vent is located. In these cases, the ideal solution would be to rearrange the ventilation to discharge directly to outside and not via a common duct.



54.16 Again, the difficulties of access to retrofit intumescent fire dampers in an occupied block of flats, particularly where these are leasehold flats, need to be considered.

55. Means of escape

55.1 The means of escape in a block of flats can be considered to comprise two distinct, but obviously linked, components:

- means of escape from an individual flat
- means of escape from the exit of each flat, using the common horizontal and vertical routes in a building, to a final exit leading to a place of ultimate safety outside.

56. Means of escape within the flat

56.1 The provision of means of escape from flats depends on a number of factors including the height and position of the flat and the number of floors or levels within the flat. Irrespective of the design, size or layout, the important principle to consider is that a fire anywhere within a flat should not prevent the occupants of that flat from escaping unaided to an exit from the flat.

Inner rooms

56.2 An inner room is a room from which escape is only possible by passing through another room (access room). These situations can commonly occur in larger flats and will also occur in open plan layouts and galleries. In addition, it is not uncommon for the occupants of flats to remove internal doors or partitions, thereby creating inner room situations.

Figure 2 – Inner room situation

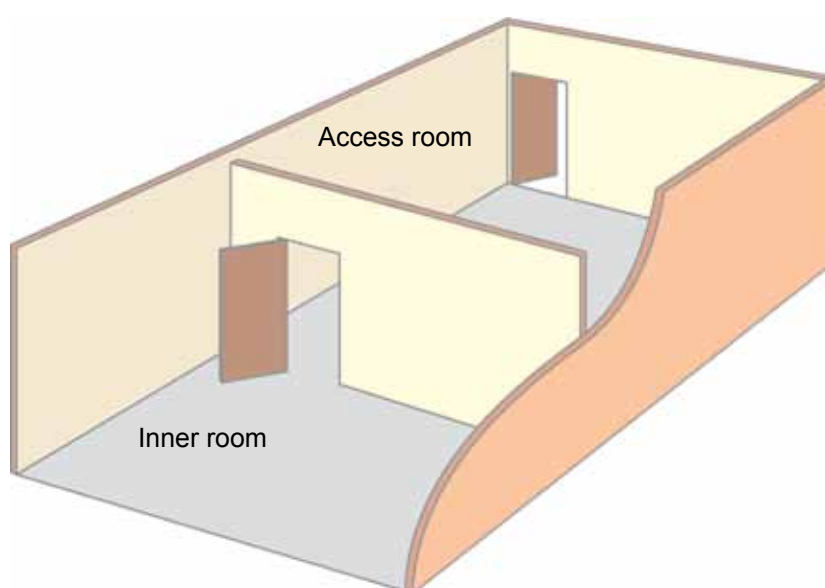

56.3 In general, any inner room that is used as a habitable room, other than a kitchen, (eg a bedroom, living room or dining room) should be provided with an alternative exit that leads to a place of safety beyond the flat.

56.4 A suitable alternative exit would be:

- a door to an access corridor, access lobby or common balcony
- an internal private stairway leading to another level, giving access to one of the above
- a door to a common stairway, external stairway or to an escape route over a flat roof
- in the case of basement, ground floor and first floor flats, a suitably sized window or door leading directly to outside – where the floor is no more than 4.5 metres (m) above ground level.

56.5 Any emergency window or door should be fit for purpose, and the residents of the flat should be able to escape unaided using the window or door to reach a place of safety. In circumstances where the residents are older, mobility impaired or disabled, they may not be able to use the alternative exit, particularly a window exit. Additional measures may be required or restrictions placed on occupancy. A specification for an emergency escape window is given in Approved Document B.

56.6 The provision of alternative exits via linking balconies, pass-doors between adjoining flats and break-out panels within the flat has featured in previous guidance and can be found in many existing blocks of flats. However, these arrangements are no longer recommended (see 56.27).

56.7 Where none of the above arrangements are practicable, a fire engineering solution based on automatic fire detection and a sprinkler, or other suitable fixed automatic suppression system, could be considered. However, in this case, the access room should not be a kitchen.

Flats with no floor more than 4.5m above ground or access level

56.8 Current benchmark design guidance for new purpose-built blocks of flats recommends the following.

- Single storey flats on ground or first-floor levels: all habitable rooms, except kitchens, should open directly onto a hallway leading to the entrance door or an alternative exit, or be provided with an escape window or door.
- In flats on two levels: on the ground floor, all habitable rooms, except kitchens, should open directly onto a hallway leading to the entrance door or an alternative exit, or be provided with an escape window or door. On the first floor, all habitable rooms, except kitchens, should be provided with an alternative exit via an escape window or door, or open directly onto an internal protected stairway leading to an exit.

56.9 In flats on two levels, a single alternative exit can serve two rooms on the upper level, provided that:

- each room has a door which opens onto the stairway
- a pass door is provided between the two rooms, so that the occupants do not have to pass through the stairway enclosure or inner lobby to reach the alternative.

56.10 In a flat on two levels, the provision of alternative exits from each room is a relatively new design principle. There will be many flats where the occupants of habitable rooms may need to access the unprotected stairway and hallway to reach an exit from the flat. Provided that there are smoke alarms on each level (see later), this arrangement is considered to be acceptable in most circumstances. However, where occupants are considered to be particularly vulnerable to fire, the lounge and kitchen doors should be fire-resisting.

Single-storey flats located more than 4.5m above ground or access level

56.11 There are three commonly acceptable approaches to providing adequate means of escape from flats where all rooms and the entrance door are on a single level. These are:

- limit the travel distance within the flat
- provide a protected entrance hall
- provide an alternative exit.

Flats with limited travel distance

56.12 The travel distance from any point in a habitable room to the flat entrance door is limited. This reduces the chance that residents could become trapped in the event of a fire (see figure 3).

56.13 Current design guidance for flats with limited travel distance is as follows.

- The travel distance from any point in a habitable room to the flat entrance door should be limited to 9m.
- Cooking facilities should be remote from the entrance door and should not prejudice the escape route from any point in the flat.

Figure 3 – Flat with limited travel distance

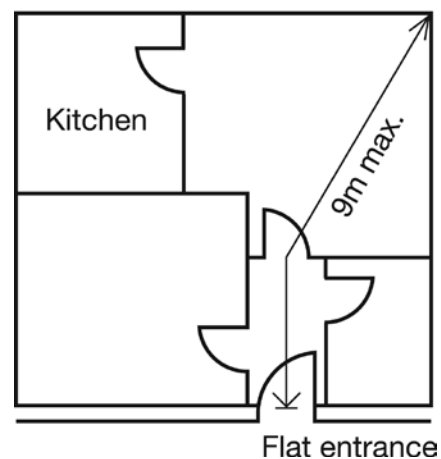
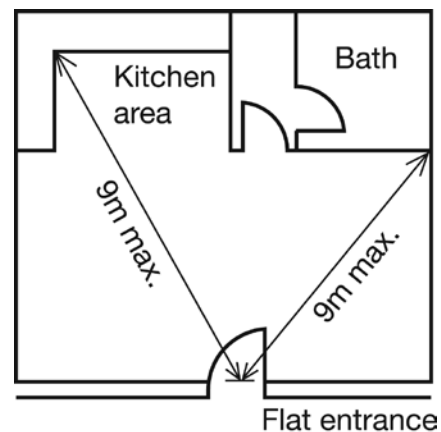

56.14 The acceptability of departures from the current benchmarks above should take account of the individual circumstances in the flat, including social factors and lifestyles of the residents. Slightly increased travel distances of, say, an additional 3m might not require any additional measures. However, other approaches, or additional compensatory measures, are likely to be necessary if travel distances in excess of this are involved.

56.15 Compensatory measures might include increased levels of automatic detection and fire-resisting doors to any kitchen or lounge.

Flats with protected entrance hall

56.16 With a protected entrance hall, the escape route within the flat should remain relatively smoke free in the early stages of a fire in a room. But, as an additional safeguard, the length of travel in the entrance hall is limited (see figure 4).

56.17 Current design guidance for flats with protected entrance halls is as follows.

- All habitable rooms should open onto the entrance hall.
- The travel distance between a door to a habitable room and the entrance door to the flat should be limited to 9m.
- The entrance hall should be a protected route, with 30-minute fire-resisting construction and 20-minute fire-resisting doors.

56.18 Slightly increased travel distances of, say, an additional 3m might not require any additional measures. However, if travel distances in excess of this are involved, other approaches, or compensatory measures, are likely to be necessary. For example, automatic detection should be provided in the kitchen and living room. In extreme cases, automatic detection might also be provided in bedrooms.

Figure 4 – Flat with a protected entrance hall

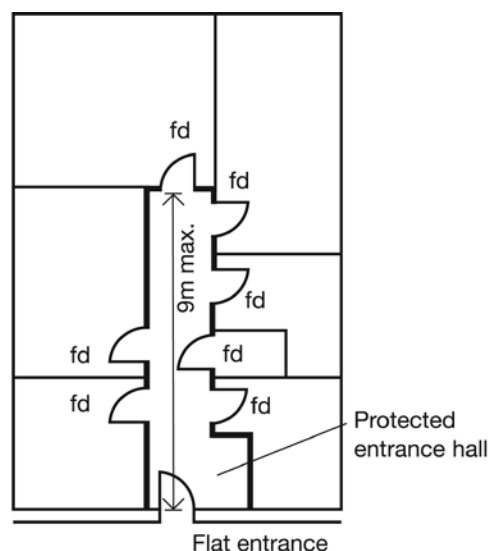

Note: Bathrooms need not have fire doors providing the bathroom is separated by fire-resisting construction from the adjacent rooms.

Key

fd Fire door

— 30 minute fire-resisting construction around entrance hall

- 56.19 In older blocks of flats, it is not unusual to find that only the partitions and doors to kitchens and living rooms are fire-resisting (see Appendix 1). Whether there is a need to upgrade doors and partitions to bedrooms in these circumstances will depend on the overall risk. For example, this may not be necessary where the travel distance in the entrance hall is no more than 12m and automatic detection is provided in the hallway of the flat. Where the travel distance is in excess of 12m, additional automatic detection should be installed in the living room and kitchen, and, either all doors onto the hallway should be fire-resisting doors or further automatic detection should be installed to cover all other rooms, including bedrooms (but not toilets and bathrooms).
- 56.20 Fitting self-closing devices to internal fire-resisting doors that open onto protected entrance halls was a normal requirement of previous benchmark standards. In many cases, in older blocks, these would have been rising butt hinges, which, over the years, have often become ineffective.
- 56.21 Fitting self-closing devices to internal fire-resisting doors in flats is no longer recommended in the latest guidance to the Building Regulations. This, in part, is in recognition of the fact that many residents remove these devices or hold doors open. The emphasis today is on educating residents to close these doors when people are sleeping.
- 56.22 This then raises the question as to whether or not internal fire-resisting doors that were originally required to have self-closing devices should have these devices reinstated to meet the standard of the day.
- 56.23 In general, it would seem inappropriate to require doors to be self-closing, providing the other current benchmark standards for means of escape can be achieved. However, as a further compensating feature for excessive travel distance, consideration might be given to fitting positive action, self-closing devices to high hazard rooms, eg the kitchen and living room, particularly where the latter are closer to the entrance door than the bedrooms.
- 56.24 It is not uncommon to find in some circumstances that residents have either changed internal fire doors to non-fire-resisting doors or have removed doors and, in some cases, partitions, altogether, thus creating inner rooms. Reinstating the fire doors and partitions will ensure adequate means of escape. This may be necessary to protect the common means of escape where there is dependence on the protection of the internal hallway to safeguard the communal escape routes.

Flats with an alternative exit

56.25 Current design guidance for flats with alternative exits is as follows.

- Alternative exits should be remote from the entrance door.
- The alternative exit should lead to a final exit or common stairway.
- Various alternative exit routes are acceptable including a common corridor, lobby or balcony leading to a common stairway, an internal private stairway leading to common parts on another level; an external stairway and an escape route over a flat roof.

56.26 Flats provided with alternative exits should allow access from all habitable rooms to both the main entrance door and an alternative exit. Internal fire-resisting partitions may be required between living areas and bedrooms particularly where habitable rooms (bedrooms) do not have direct access to the entrance hall. (See figure 5.)

56.27 Escape via linking balconies, or pass doors between neighbouring flats, was a commonly accepted alternative escape arrangement under previous benchmark standards and can be found in many existing blocks of flats. However, these arrangements are no longer recommended for the design of new flats. In most of these situations, the linking balcony, and pass doors, were shared by the residents of two adjoining flats. In some other situations, more than two flats shared the linking balcony but, in all cases, there was a need to gain access into a neighbour's flat to reach an alternative exit route.

Figure 5 – Flat with an alternative exit, but where all habitable rooms have no direct access to an entrance hall

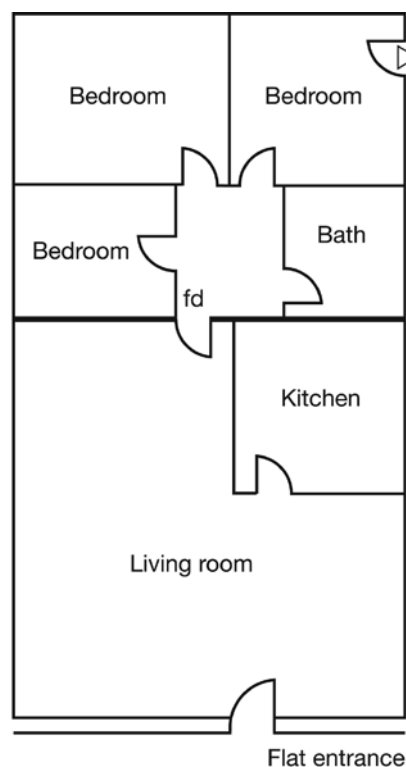

Note: The bedrooms are not classified as inner rooms because escape is possible in two directions.

Key

fd Fire door

— 30 minute fire-resisting construction between living and bedroom accommodation

△ Alternative exit

56.28 The difficulties of ensuring access into, and exit from, an adjoining flat to reach an alternative exit are obvious and cannot be relied on with any degree of certainty to be available at all times.

56.29 Despite the above, in many existing flats, the provision of other, more suitable alternative exit routes, such as common balconies or stairways, will be impractical to achieve. In these situations, either one of the other two approaches (limited travel distance or protected entrance hallway) should be adopted, or compensatory measures will need to be considered. The latter include:

- pass doors between internal rooms to access a protected exit route
- additional automatic detection to a Category LD2 or even LD1 standard
- a sprinkler, or other suitable fixed automatic suppression, system.

56.30 However, there may be circumstances where, even with these additional measures, the access to the linking balcony or the pass doors might still be retained for use as a last resort.

Flats with more than one storey, with a floor at more than 4.5m above ground level

56.31 The internal means of escape from flats with more than one storey (eg maisonettes and cross-over flats), with a floor at more than 4.5m above ground level, provide additional issues to those encountered in flats on one level. Nevertheless, the basic approaches of providing either a protected exit route or an alternative exit remain the same.

56.32 Current benchmark design guidance recommends four approaches to the planning of means of escape from these flats:

- i. provide an alternative exit from each habitable room that is not on the entrance level
- ii. provide a single alternative exit from each level, other than the entrance level, and provide a protected landing and hallway
- iii. provide a protected route and install additional automatic detection
- iv. provide a protected route and install an automatic suppression system.

56.33 The first solution (i) is that all habitable rooms not on the entrance level should be provided with an alternative exit (see figure 6). The stairway landing is not required to be protected in these situations. The entrance hall is only required to be protected if the maximum travel distance from any point in a room to the flat entrance door is more than 9m and there are no alternative exits from each of the rooms on that level.

56.34 The second solution (ii) is to provide a single alternative exit on the non-entrance level, either within a room or on the landing. This could be accepted in any of the following situations.

- All habitable rooms open directly onto a protected entrance hall and landing (see figure 7).
- A fire-resisting partition is provided at the head or base of the stairway to separate the entrance level from the level with the alternative exit. (The landing need not be protected provided the maximum distance between any point in a room on the non-entrance level and the alternative exit does not exceed 9m.)
- The alternative exit is within a room on the non-entrance level. Pass doors are provided between habitable rooms on this level, so that residents do not have to enter the stairway enclosure to reach an alternative exit.

56.35 In some existing flats, none of the above solutions may be feasible. In these situations, an alternative option could be to provide a protected route only on the entrance level. It might not be necessary for there to be a protected landing, provided the maximum distance between any point in a room on the non-entrance level and the alternative exit does not exceed 9m.

Figure 6 – Multi storey flat with alternative exits, from each habitable room, except at entrance level

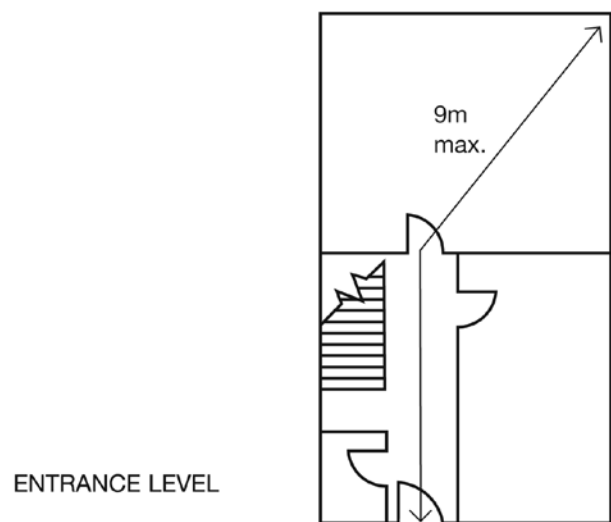
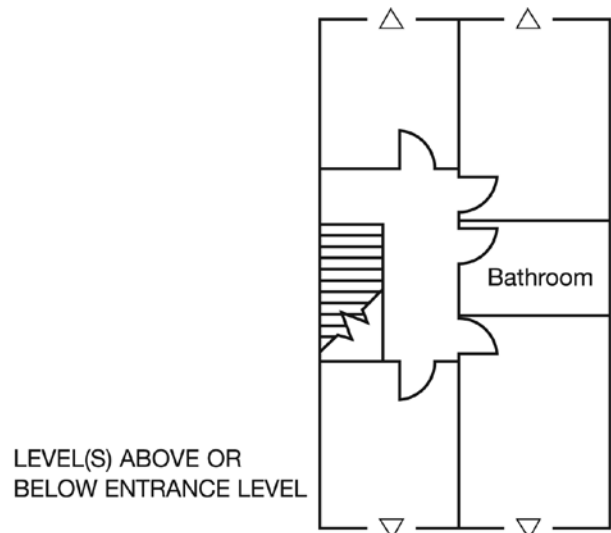

Note: This only applies where at least one storey is more than 4.5m above ground level.

Key
▲ Alternative exit

56.36 Cross-over flats can sometimes present particular problems because of the complexity of design and layout. Cross-over flats are flats on more than one level and the principles set out above can be applied. However, the complexity of this arrangement will require careful consideration of the means of escape, and specialist advice may need to be sought.

56.37 The third solution (iii) is to provide a protected route and to install additional automatic fire detection. This applies to flats where the vertical distance between the entrance level of the flat and any floors above or below does not exceed 7.5m. The entrance hall, stairway and landing should be a protected route and additional automatic detection, in all rooms (other than toilets or bathrooms), should be provided (a Category LD1 system as defined in BS 5839-6).

56.38 The fourth option (iv) is to provide a protected route and install an automatic suppression system. The entrance hall, stairway and landing should be a protected route. A sprinkler or water mist system should be installed throughout the flat, together with an automatic detection in the circulation spaces (a Category LD3 system as defined in BS 5839-6).

Figure 7 – Multi-storey flat with protected entrance hall and landing

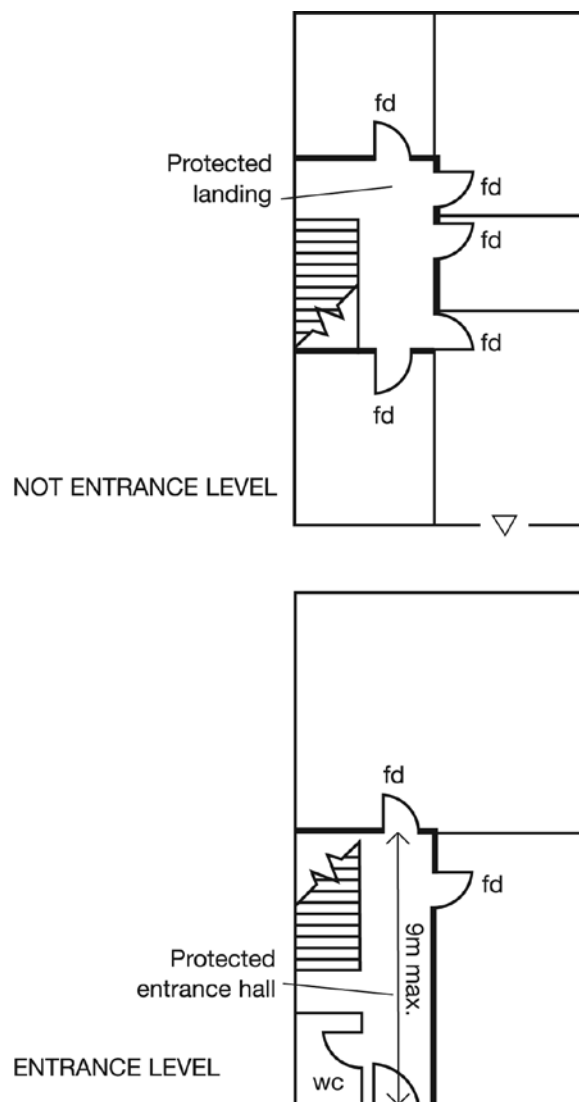

Note: This only applies where at least one storey is more than 4.5m above ground level.

Key

- fd Fire door
- 30 minute fire-resisting stair enclosure
- △ Alternative exit

57. Escape routes within the common parts

57.1 Escape routes from a flat to ultimate safety outside the building rely on using the common parts. There are two elements to this:

- horizontal escape from the flat entrance door to a stairway
- vertical escape via a stairway leading to a final exit.

57.2 Adequate levels of fire protection need to be provided to the communal escape routes so that smoke and heat from a fire in a flat or ancillary room will not prejudice use of the corridors, lobbies, external balconies or stairways. This will include provisions to ensure that the common escape routes remain relatively smoke free and safe to use in the event of a fire.

57.3 In general, in existing blocks of flats, to access the flat entrance doors, it is necessary to use either an internal corridor or lobby, or an external balcony or deck, off a common stairway. The provisions required to safeguard the escape routes in each of these scenarios will vary.

58. Escape from flats with internal corridor or lobby approach

58.1 Current benchmark design guidance recommends two methods of ensuring that the horizontal escape routes can be safely used in the event of a fire. These are:

- provide protected corridors and lobbies leading to a stairway and limit the distance of horizontal travel
- provide independent alternative escape routes from each flat, either by way of a common internal corridor at another level or by an external common balcony, in both cases leading to a stairway.

Protected corridors or lobbies

58.2 The corridors and lobbies used for means of escape need to be protected routes ie enclosed in construction with at least 30 minutes fire resistance. As discussed earlier, walls between flats and the common parts need to be compartment walls and, as such, will provide the necessary fire resistance. Ancillary rooms, risers and other areas opening onto corridors and lobbies also need to provide this protection.

58.3 Doors from ancillary rooms, as well as flat entrance doors, need to be fire-resisting. The current benchmark for doors opening into internal corridors and lobbies should be capable of providing 30 minutes fire resistance and – with the exception of risers and ancillary rooms – the doors need to be self-closing.

Stairways

- 58.4 Stairways need be enclosed in fire-resisting construction to minimise the risk of flames and smoke entering the stairways while they are being used for escape. Again, the current benchmark for doors is that they be capable of providing 30-minute fire resistance and be self-closing.
- 58.5 Stairways should lead directly to a final exit, or to a protected route leading to a final exit. The stairways should not contain any significant fire hazards and should, ideally, not contain anything other than lifts or protected electrical meter cupboards. Ideally, gas installations should not be located within protected stairways.
- 58.6 It is unlikely that the width of stairways will be a significant issue with regard to their capacity for use for escape, as there is normally no requirement for simultaneous evacuation of purpose-built blocks of flats. Therefore, the number of people expected to use a stairway in the event of a fire will be limited. Widths of 1,000 millimetres (mm) would normally be considered adequate for means of escape in most cases. Indeed, narrower stairways may well be found in some existing buildings, and these will generally be acceptable depending on the circumstances.
- 58.7 In single stairway buildings, other than in small blocks of flats (less than four storeys), the stairway should, ideally, not continue down to serve a basement or enclosed car park. In multiple stairway buildings, where the stairways serve basements and car parks, one of the stairways should, preferably, be terminated at ground level. Other stairways may extend to serve basements, providing they have lobby or corridor protection at basement level.
- 58.8 Except in small blocks of flats, a single stairway should, ideally, not serve any boiler room, fuel storage room or other similar high-risk ancillary rooms. In multiple stairway blocks of flats, the ancillary rooms should, normally, be separated from the stairways by a protected lobby or corridor.

Smoke control

- 58.9 Both current design guidance and previous standards for purpose-built blocks of flats recommend that measures be provided to ensure that escape routes remain free of smoke. However, different approaches have been employed in order to achieve this, and, indeed, the philosophy behind smoke control design has changed over the years.
- 58.10 The current benchmark design guidance is based on using smoke control to protect the common stairways. While this might afford some protection to the corridors and other horizontal routes, this is not the design intent. The emphasis in previous design guidance has been on protecting not only the stairways, but also the entire horizontal route to them.
- 58.11 The current approach is that of smoke containment, with ventilation of lobbies and corridors where they adjoin a stairway. That ventilation can be achieved by natural or mechanical means.

58.12 Natural ventilation, either direct to open air or via smoke shafts that rise up through the building, involves the provision of vents or windows, usually of minimum free area of 1.5 metres squared (m²). These can be:

- permanently open vents (PVs), as recommended in some previous design guides
- manually openable vents (OVs)
- automatically opening vents (AOVs).

The latter is operated by smoke detectors provided specifically for this purpose. The method of operation employed is dependent on the design of the block of flats.



58.13 Current guidance states that vents in lobbies or corridors adjoining single stairways should be operated automatically (AOVs). In multiple stairway blocks, manually openable vents will suffice.

58.14 Protected stairways also need means to ventilate any smoke that may enter the stairway during evacuation or fire fighting and allow a route for air to reach ventilated lobbies and corridors. A vent of at least 1m² needs to be provided at the head of the stairway for this. Current guidance states that, in blocks of flats with more than one escape stairway, this vent can be opened manually. But, in blocks of flats with a single stairway, it is recommended that the vent is operated automatically (an AOV).

58.15 Mechanical ventilation systems can achieve the same objective in protecting a stairway and, in some respects. More effectively, given that they are less influenced by wind effects. These usually comprise pressurisation systems to keep smoke out of the stairway.

58.16 A further part of the containment principle is the subdivision of corridors linking stairways and the separation of any dead-end sections from the rest of the corridor. This is to ensure that smoke will not affect access to more than one stairway or, in the case of the dead ends, affect access to the nearest stairway.

Surface finishes in common escape routes

58.17 The surface finishes of walls and ceilings in escape corridors, lobbies and stairways can significantly affect the rate of fire-spread and contribute to the development of a fire. It is, therefore, important to control the fire performance of linings within the common parts.

58.18 Combustible surface finishes should not be permitted in escape corridors, lobbies or stairways. Products and materials that will afford a 'Class 0' (or European class B-s3, d2)

performance are normally necessary for use in the common areas of blocks of flats. This is a classification defined in Approved Document B.

58.19 In general, where a wall or ceiling is constructed of non-combustible materials, such as masonry, brick, concrete or plasterboard, or has plaster finishes, the fire performance characteristics will be acceptable in the common escape routes.

58.20 However, in existing blocks of flats, it is often difficult to identify the classification of existing surface finishes, particularly if the materials used are not obvious. Even those finishes normally considered acceptable may have been subject to many instances of over-painting. This can affect their performance when exposed to fire.

58.21 Multiple layers of paint have, over the years, been applied to walls and ceilings in the common parts of blocks of flats. The build-up of paint layers can give rise to rapid fire-spread. In these situations, where the risk is considered significant, action should be taken to remove or treat the paint. Proprietary products are available that can be used to treat the surfaces to provide a protective outer coating that will reduce the extent of fire-spread. Treatments are also available for timber linings.

58.22 False ceilings can sometimes be found in the common corridors and lobbies of blocks of flats. The materials used to construct the ceilings and the surface finishes should preferably be non-combustible or, at least, Class 0. There should be little or no additional fire hazards within the false ceilings. On this basis, there may not be a need for cavity barriers to sub-divide the voids, but this would need to be considered in each circumstance.

Benchmark guidance

58.23 The following reflects the current benchmark design guidance for both single and multiple stairway blocks of flats with corridor or lobby access.

Flats served by a single escape stairway

58.24 Current benchmark design guidance for flats with a single escape route from a flat entrance door to the stairway is as follows.

- Every flat should be separated from the common escape stairway by a protected corridor or lobby.
- The distance of travel between the flat entrance door and the door to a lobby or stairway should be limited to 7.5m.
- Smoke control should be provided by natural or mechanical ventilation in the lobby or corridor adjacent the stairway.
- The smoke vents on the fire floor and the vent at the head of the stairway should be operated automatically by means of smoke detectors in the common access corridor or lobby to the flats.

Figure 8 – Flats served by a single escape stairway

A. Corridor access flats

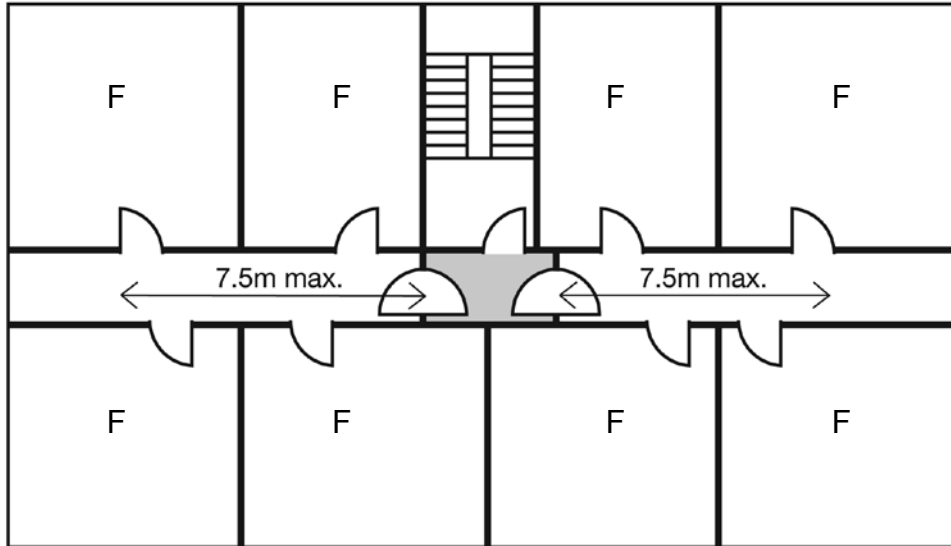

B. Lobby access flats

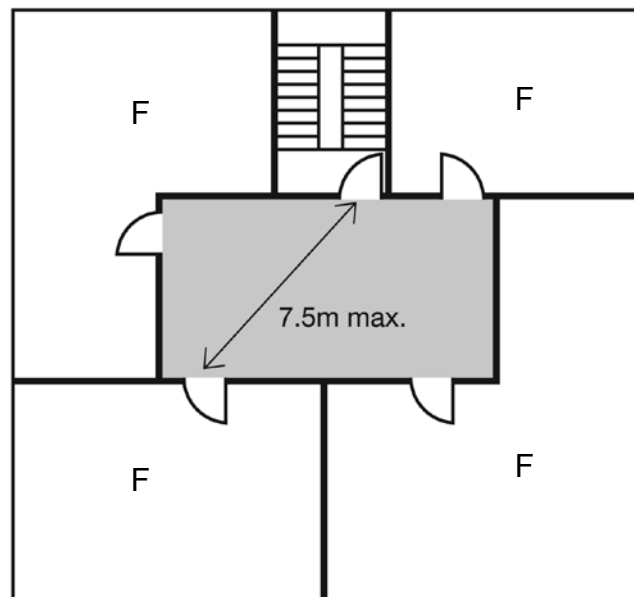

Note:

1. All doors shown are fire doors.
2. Where travel distance is measured to a stair lobby, the lobby must not provide direct access to any storage room, flat or other space containing a potential fire hazard.

Key:

F = flat

■ Shaded area indicates a zone where smoke ventilation should be provided. (An external wall vent or smoke shaft located anywhere in the shaded area)

Small single-stairway buildings

58.25 Where a single-stairway building is small, relaxations in the provisions apply, providing:

- the top floor of the building is no more than 11m above ground level
- there are no more than three storeys above the ground level storey
- the stairway does not connect to a covered car park
- the stairway does not serve ancillary accommodation, unless the ancillary accommodation is separated from the stairway by a protected lobby or corridor with a permanent natural vent or ventilation by a mechanical smoke control system
- there is an openable vent provided on each floor level for use by the fire and rescue service, or alternatively, there is a remotely operated vent at the head of the stairway.

58.26 Current benchmark design guidance for small, single stairway blocks is as follows:

- every flat is separated from the common escape stairway by a protected corridor or lobby
- the distance of travel from flat entrance doors to the stairway should be limited to 4.5m – if smoke control is provided in the lobby, the travel distance can be increased to 7.5m
- in single-stairway buildings with only two flats per floor, the lobby between the stairway and the flats is not essential, providing the flats have protected entrance halls – in these circumstances, the vent at the head of the stairway should be an AOV operated by smoke detectors.

Flats with more than one escape stairway

58.27 Current benchmark design guidance for blocks with more than one common escape stairway and alternative routes from the flat entrance door to a stairway is as follows.

- every flat should be separated from each common escape stairway by a protected corridor or lobby
- the travel distance from a flat entrance door to the door to the nearest stairway or lobby should be limited to 30m
- a common corridor that connects two or more escape stairways should be subdivided by a self closing fire-resisting door to ensure smoke will not affect access to more than one stairway – this door can be omitted if the maximum travel distance from a flat entrance door to a stairway or lobby is not more than 15m
- any dead-end section of an access corridor should be separated from the rest of the corridor by a self-closing fire-resisting door – the single direction of travel in the dead-end section of corridor should be limited to 7.5m
- smoke control by natural or mechanical ventilation should be provided in the lobby or the corridor adjacent the stairway to protect the stairway
- an openable vent should be provided at the head of the stairway.

Figure 9 – Flats served by more than one escape stairway

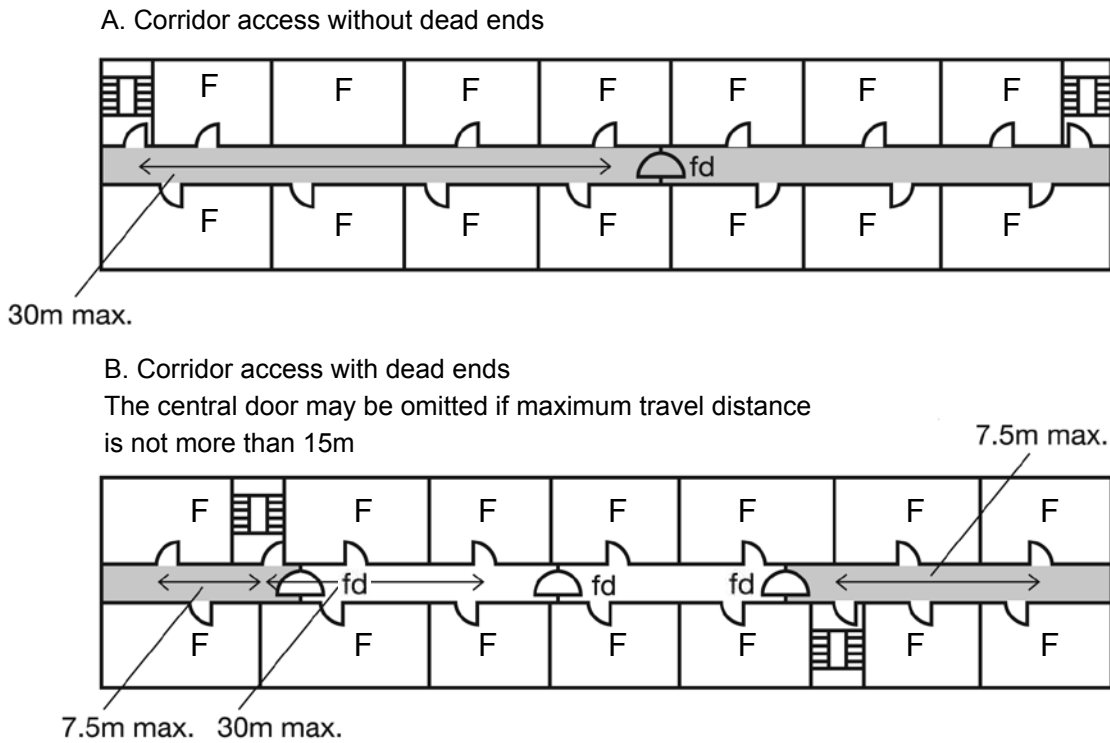

Key:

F = flat

fd = fire door

■ Shaded area indicates a zone where smoke ventilation should be provided. (An external wall vent or smoke shaft located anywhere in the shaded area).

58.28 The maximum distances of travel specified above do not apply in flats with both single and multiple escape stairways, where all flats on a storey have independent alternative means of escape leading to an access corridor or access lobby at another level. In these situations, the distances specified for fire and rescue service access detailed in 71.5 will apply.

59. Escape from flats with external balcony or deck access approach

59.1 If the width of the access balconies or deck is less than 2m, it can be assumed that there is little risk of horizontal smoke spread along the balcony or deck from a fire in a flat, that would prevent residents from using the escape route. There is, however, some potential for smoke-spread along balconies or decks wider than 2m. In these situations,

downstands may need to be considered to restrict the lateral spread of smoke along the balcony or deck.

- 59.2 Ideally, there should be no additional fire hazards, such as stores or other ancillary rooms, located off the balcony or deck.
- 59.3 There are no limitations on travel distance in the common escape routes for flats with external balcony or deck approach. However, the distances specified for fire-fighting access later will apply. All areas of a flat should be within 45m of the fire-fighting vehicle access point, or within 45m of a landing valve of a dry rising main (60m when the landing valve is in a fire-fighting shaft).
- 59.4 In blocks of flats where there is alternative escape available from each flat entrance along the open balcony or deck to two or more escape stairways, the separating walls between the flats and access balcony or deck and the flat entrance doors are not required to be fire-resisting.
- 59.5 In flats with a single direction of escape to a single escape stairway, the separating walls between the flats and the balcony or deck should be fire-resisting up to a height of 1.1m from balcony or deck level. The flat entrance doors in these situations should be self-closing fire-resisting doors.
- 59.6 This will allow residents, if they wish, to pass a fire in an adjoining flat to reach the stairway. In flats with alternative independent escape to another balcony or deck on the same level, which leads back to the single stairway, only one of the enclosures between the flats and the balcony needs to be fire-resisting.

60. External stairways

- 60.1 Current benchmark design guidance is that external stairways should be limited to serve floors not more than 6m above ground level. However, in existing blocks of flats, there may be external stairways over this height, and it would be unreasonable not to continue to rely on them simply because of this height limitation.
- 60.2 In these situations, it should be ensured that the stairway remains safe to use at all times in the event of a fire. External stairways need to be protected from a fire in the building by means of fire-resisting partitions, fire-resisting glazing and self-closing fire-resisting doors.

61. Escape routes over roofs

- 61.1 Current benchmark design guidance recommends that, if more than one escape route is available from a storey, one of the routes may be by way of the roof of a block.
- 61.2 Not only do some existing blocks of flats utilise escape across a roof, there are some in

Figure 10 – Common escape routes in balcony/deck approach blocks

A. Multi-stair building

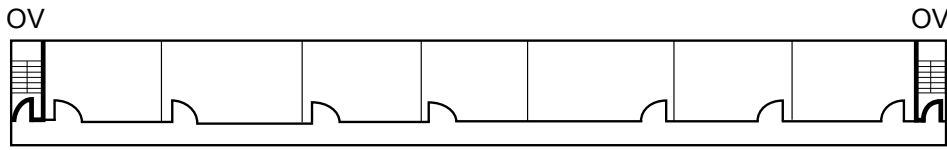

B. Single stair building

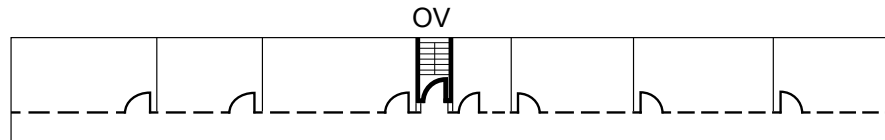

C. Single stair building with an alternative exit from every flat

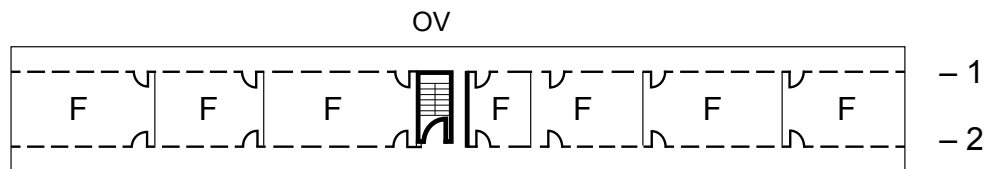

Note 1: Either external closure 1 or external closure 2 should be fire resisting.

Key:

OV Openable vent for fire service use (1.0m² minimum)

— Fire resisting construction

-- Fire resisting construction up to a height of 1.1m above deck level

⌒ Self closing FD30S fire door

Note 2: All doors breaching the 1.1m high fire resisting separation should be self closing FD20 fire doors.

Note 3: Although there are no limitations on travel distance, all parts of the building need to be within 60m of a fire main, measured along a line on which a hose can be laid.

Note 4: The OVs to a stairway may be replaced by an openable vent over the stair.

which upward escape is necessary to reach the roof. In these situations, fire-resisting doors need to be provided across the stairways to separate the route down from the route up.

61.3 If escape across a roof is encountered, it should be ensured that:

- the roof is not accessed by means of a ladder or other route that cannot be readily used by mobility impaired people
- the roof is flat
- the route across the roof leads to a protected escape stairway (which may be in an adjoining building) or leads to an external stairway



Figure 11 – Protection to an external stairway

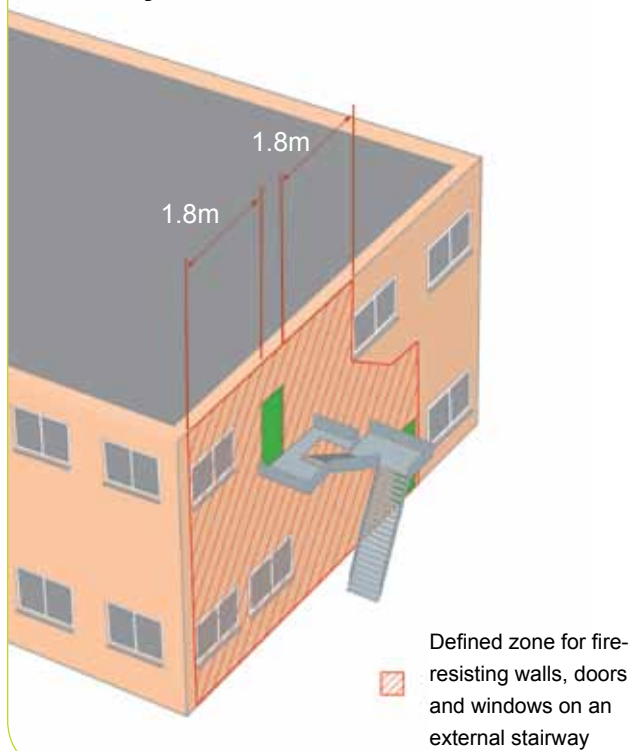
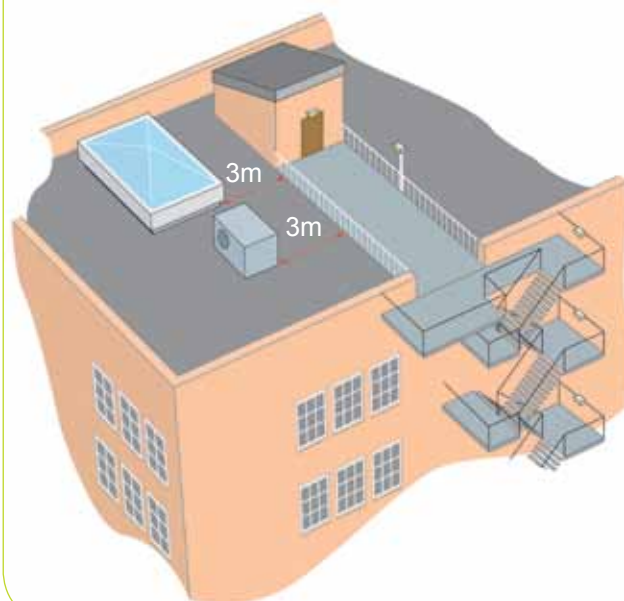

Figure 12 – Escape route across a roof



- both buildings and/or stairways are under the same control of the landlord or owner, or, alternatively, there are legal agreements in place to ensure right of access to use the route
- the route across the roof is adequately defined and guarded
- there is adequate emergency lighting and signage as necessary
- the part of the roof forming the escape route and its supporting structure is fire-resisting.

62. Blocks of flats that do not meet the current design benchmarks for means of escape

62.1 Although the above benchmarks reflect current design guidance, many existing blocks of flats, designed to earlier standards, or in which alterations have taken place, will not comply with these benchmarks. For example:

- existing blocks of flats may have increased travel distances
- there may be no corridor or lobby protection to the stairways
- smoke control arrangements may be non-existent or differ from what is acceptable today.

The latter will be particularly relevant in blocks of flats designed on the principles of smoke dispersal, where increased travel distances were permitted. Also, the requirement for lobby protection in single stairway blocks of flats was also different in earlier guidance, with flats in some blocks over four storeys in height opening directly onto the stairways and the number of flats per floor exceeding current recommendations for small blocks.

62.2 In these circumstances, upgrading to current standards, although ideal, may not be possible, due to the physical constraints in the building, or justifiable on the basis of risk. Therefore, there will be a need to consider the overall risk.

62.3 In some blocks, restoring the block back to the standard of the day might be all that is needed. In others, compensatory measures might need to be considered. In exceptional circumstances, automatic fire detection and alarm systems and automatic fire suppression systems might also need to be considered.

62.4 The acceptance of standards in existing blocks of flats, where they significantly differ from current benchmarks, should be subject to careful scrutiny. This may require assessment by a suitable specialist. However, the following general guidance may assist when considering the available options for means of escape.

62.5 The following scenarios are considered.

- Blocks of flats with increased travel distance.
- Blocks of flats in which the flats open directly onto a stairway.
- Blocks of flats with unsatisfactory smoke control arrangements.
- Blocks of flats in which fire-resisting doors pre-date current standards.

Increased travel distance

62.6 The travel distances specified earlier have been found to achieve the requisite level of safety, but were never intended to be hard and fast, and different limits have applied in the past (see Appendix 1). The acceptance of increased distances of travel may be considered appropriate in individual circumstances. This will be particularly relevant in older types of property, where there will be little scope to reduce the existing travel distances or provide alternative means of escape.

62.7 Small increases in travel distance can be accepted in most situations without any additional measures. However, additional measures may need to be considered if there are significant increases in travel distance. These might include:

- additional cross-corridor doors to restrict smoke-spread
- improvements to the smoke control arrangements
- in rare cases, automatic fire detection.

A possible approach to this situation when found in existing buildings is as follows.

Benchmarks for existing blocks of flats (corridor or lobby approach) – single direction escape

- In unventilated lobbies, increases from the 4.5m limit to 6m are likely to be acceptable with no additional measures.
- In unventilated lobbies, increases up to 7.5m will require additional measures, such as ‘upgraded FD30S’ doors (see later). Beyond 7.5m, the lobby should be ventilated.
- In ventilated lobbies and corridors, increases from 7.5m up to 10m are likely to be acceptable in most situations with no additional measures.
- In ventilated lobbies and corridors, travel distances of ten to 15m may be acceptable, providing all doors to the common corridor or lobby are at least ‘upgraded FD30S’ doors (see later) and the smoke ventilation comprises PVs or AOVs.
- In ventilated lobbies and corridors, travel distances over 15m are likely to be unusual, and cannot be considered acceptable without additional measures, which might include ‘replacement FD30S’ doors, AOVs or automatic fire detection. The advice of specialists will be necessary.

Benchmarks for existing blocks of flats (corridor or lobby approach) – escape in two directions

- Increases from 30m to 40m (eg resulting from a change from smoke dispersal to smoke containment) should be acceptable in most situations without the need for additional measures.
- Travel distances in excess of 40m will only be acceptable with additional measures, which might include ‘replacement FD30S’ doors, AOVs and/or automatic fire detection. The advice of specialists will be necessary.

Flats opening directly onto stairways

62.8 As indicated in Appendix 1, previous regulations and guidance have permitted flats to open directly onto stairways above the limits in height currently considered acceptable. The introduction of common lobbies in these buildings is not a realistic proposition. A possible approach to this situation when found in existing buildings is as follows.

Benchmarks for existing blocks of flats with flats opening directly on to a single stairway

- Up to four storeys in height, should be acceptable in most situations, provided the stairway has openable windows or vents.
- Up to six storeys in height, should be acceptable, providing the walls enclosing the stairway are 60 minutes fire-resisting, flat entrance doors are at least ‘upgraded FD30S’ doors and the stairway has openable windows or vents. Within flats there should be internal entrance halls protected with fire-resisting doors to the kitchen and lounge, but not necessarily bedrooms.
- Over six storeys, should not be accepted without additional measures. These are likely to include AOVs and ‘replacement FD30S’ front doors, but might include fully protected entrance halls within the flats and automatic fire detection. The advice of specialists will be necessary.

Unsatisfactory smoke control

62.9 Although there have been changes in smoke control design, it is still appropriate, when assessing an existing building’s smoke control arrangements, to review these in the light of the standards that were in place at the time the block was built. Start by ensuring that what is there continues to work as originally intended before considering the need to improve the arrangements. However, in relation to smoke dispersal previous benchmark design guidance is far removed from what is acceptable today.

62.10 Smoke dispersal has proved to be very unreliable for a number of reasons, and is no longer seen as an accepted method of smoke control. In existing blocks of flats with smoke dispersal, action should be taken to review both the smoke control arrangements and the existing travel distance. The advice of specialists may need to be sought.

62.11 An approach to three commonly found situations, in which there are unsatisfactory smoke control provisions, is as follows.

Benchmarks for existing blocks of flats with unsatisfactory smoke control

- In single staircase blocks up to six storeys, in which flats open directly onto the stairway, manually opening vents or windows would be acceptable.
- In single stairway blocks over six storeys, in which flats open directly onto the stairway, AOVs should be provided.
- In single stairway blocks with corridor or lobby approach requiring smoke ventilation, and with travel distances of 7.5 to 10m, OVs in corridors or lobbies are acceptable up to six storeys in height. If this travel distance exceeds 10m, or the number of storeys exceeds six, or the ventilation is provided in the stairway and not the corridor or lobby, AOVs or PVs are required.
- In blocks of flats designed with corridor smoke dispersal systems, consideration should be given to providing cross-corridor doors to change to a smoke containment approach, but maintain the OVs or PVs to ventilate the sections of corridor remaining. Advice from a specialist should be sought if smoke dispersal is present in single stairway buildings.

Fire-resisting doors

62.12 Under current benchmark design guidance, doors forming part of the protected entrance halls and stairways within flats are normally specified as 20-minute fire-resisting doors (designated FD20). Similarly, doors forming part of the protected escape route from the flat entrance door to the final exit, including the flat entrance door itself, are normally specified as 30-minute fire-resisting doors with smoke seals (designated FD30S).

62.13 At the time they were fitted, the vast majority of these doors would have complied with the test standard or specification of the day for a 20 or 30-minute fire-resisting door. In addition, many of these doors have performed satisfactorily in a fire situation and, are likely to continue to do so, providing they remain in good condition.

62.14 A modern (FD30S) fire-resisting door has intumescent strips and cold smoke seals fitted along its side and top edges (or within the frame in these locations). Letter boxes would be of a type incorporating intumescent materials to protect the opening. The

door would be fitted with an overhead self-closing device or a concealed closer in the door jamb. The doorset, the complete entity incorporating door hardware and furniture, would be tested for its performance as a whole.

62.15 Original flat entrance doors may lack intumescent strips and cold smoke seals and will not have protected letterboxes. There would have been reliance on 25mm door stops to achieve 'smoke control'. Where older doors were self-closing, this was sometimes achieved by using rising butt hinges.

62.16 Upgrading existing doors simply because they are not fitted with intumescent strips or smoke seals, or fail to meet some other requirement of current standards, should not be made a generic recommendation applicable to all existing blocks of flats. Similarly, upgrading existing letterboxes in flat entrance doors to meet current standards is not always necessary. This will depend on:

- the location of the letterbox in the door
- the location of the flat within the block
- the construction of the letterbox.

62.17 It will not be practicable to test existing doors to confirm their actual fire resistance. Therefore, three options exist in relation to original fire-resisting doors that do not meet current benchmark standards. These are:

- accept the door as it is, provided it is a good fit in its frame and that it satisfied the standard applicable to fire-resisting doors at the time of construction of the building or manufacture of the door ('notional FD30' door)
- upgrade the door by, for example, fitting intumescent strips and smoke seals along the edges, and fitting a protected letter box ('upgraded FD30S' door)
- replace the door with an FD30S door ('replacement FD30S' door).



62.18 An upgraded FD30S door cannot be guaranteed to achieve the same performance as a replacement FD30S door, for which there will be a fire test certificate. This is to be expected and is reasonable provided that the door has sufficient thickness of timber (eg 44 millimetres). Simply fitting intumescent strips and smoke seals to a thin door or one with panels will not render it suitably fire-resisting. Specialist advice may need to be sought in order to make an assessment of the likely benefits of upgrading existing fire-resisting doors. Guidance on upgrading fire-resisting doors is also published by the Timber Research and Development Association (TRADA).

62.19 It is essential that, irrespective of which option is chosen, fire-resisting flat entrance doors, and doors provided to protect common corridors, lobbies and stairways, should be fitted with suitable positive action self-closing devices. The self-closing device should be capable of closing the door in its frame from any angle and overcoming the resistance of any latch. Rising butt hinges used to be acceptable under previous benchmark guidance, but are no longer considered suitable devices because they are unreliable in the effective closure of a door.

62.20 The fitting of suitable self-closing devices – whether to replace rising butt hinges (pictured below) or because the doors are not fitted with self-closing devices – **must** be undertaken in the short term as a matter of priority.



62.21 In many existing blocks of flats, it will normally be acceptable, taking into account the fire risk, to accept, existing fire-resisting doors and not replace or upgrade the doors as a matter of course. For this to be the case, any existing fire-resisting door will need to be well fitting in its frame and be in good condition. In addition, although it may be appropriate to upgrade or replace doors, this will not necessarily mean that this work has always to be undertaken as a matter of urgency. In many blocks of flats, the upgrading or replacement of doors can be part of a planned, and possibly phased programme.

62.22 Any new or replacement doors within an existing block of flats should meet current standards for fire-resisting doors (BS 476-22 or BS EN 1634 parts 1, 2 and 3). Similarly, any letterboxes that are fitted should be of a protected type, eg lined with intumescent material to seal the opening when exposed to fire. It may also be appropriate to consider the upgrading or replacement of doors at the time of any major refurbishment work.

62.23 The following is general guidance only and will depend on the specific circumstances in a block. It refers to flat entrance doors, but a similar approach could be undertaken when considering other doors in the common parts.

Benchmarks for existing blocks with a single stairway and with acceptable travel distance, but doors opening directly onto the stairway:

- Up to four storeys, 'notional FD30' doors should be acceptable.
- Up to six storeys, doors should be at least 'upgraded FD30S'.
- Over six storeys, doors should be 'replacement FD30S'.

Benchmarks for existing blocks with corridor or lobby access – single and multiple stairway blocks:

- Where means of escape, particularly travel distances are satisfactory, 'notional FD30' doors should continue to be acceptable.
- Where means of escape are not satisfactory, such as where there are excessive travel distances, upgraded or replacement FD30S doors are likely to be necessary, particularly in dead ends.

Benchmarks for existing blocks with external balcony or deck access – single stairway or within a dead end with acceptable travel distances:

- Notional FD30 doors should be acceptable.
- Glazing in the door above 1.1m is not required to be fire-resisting.
- A fire-resisting letterbox is not essential.
- As with all flat entrance doors, the door must be fitted with a positive action self-closing device.

There was an error on page 100 of the guide issued on 31st July 2011.
This version is the correct version. Dated 28th September 2011

63. Fire safety signs

63.1 The normal access and egress routes within a block of flats do not usually require fire exit signs to assist residents and visitors to make their way out of the building in the event of fire.

63.2 Flats with a single staircase, regardless of the number of floors, would, for example, not usually require any fire exit signage.

63.3 In other blocks, fire exit signage may be required in circumstances where there are:

- alternative exit routes
- secondary exits by way of an external stair
- across a flat roof
- where there is any potential for confusion.

63.4 In general, 'Fire Door Keep Locked Shut' signs should be provided on:

- the external face of doors to store rooms
- electrical equipment cupboards
- any ancillary rooms located within the common parts.

63.5 In general, 'Fire Door Keep Shut' signs should be provided on both faces of fire-resisting doors forming part of the protection to the common escape routes and on cross-corridor fire doors. However, this does not apply to flat entrance doors. (In the unusual case of fire doors that are held open, but release on operation of smoke detectors, the signs should read 'Automatic Fire Door Keep Clear').



63.6 Where fire exit signs are provided, they should satisfy the requirements of BS 5499-5 and be installed in accordance with the recommendations of BS 5499-4.

64. Lighting on escape routes

64.1 Adequate artificial lighting and, where necessary, emergency escape lighting should be provided in common escape routes, such as corridors, lobbies and stairways, to enable residents and visitors to make their way safely out of the building.

64.2 It is not necessary to provide escape lighting in small blocks of flats of no more than two storeys, with adequate levels of natural or street lighting (borrowed lighting). However, emergency escape lighting should be provided within all common escape routes, including, where necessary, external stairways, balconies and roof level escape routes. Where borrowed lighting is not reliable, eg street lighting switched off during part of the night, emergency escape lighting may be required even in two storey blocks.

64.3 Although many existing blocks of flats may not have emergency escape lighting, the likelihood of loss of normal lighting within escape routes, as a result of fire, at a time when residents may need to use the escape routes, is very low. Therefore, the installation of emergency escape lighting, particularly in low-rise blocks, is unlikely to be a high priority compared to other improvements, such as fitting self-closing devices on doors. However, other considerations, such as the height of the building and inadequate normal lighting may dictate the urgency with which emergency escape lighting should be installed.

64.4 Emergency escape lighting should conform to the recommendations and requirements of the relevant parts of BS 5266. It should provide illumination for three hours in the event of power failure.

64.5 One or more test switches should be provided, so that the emergency escape lighting can be tested every month by simulating failure of the normal power supply to the luminaires without the need to isolate normal lighting circuits.

65. Refuse and chute rooms

65.1 Arrangements for the disposal of waste and refuse are important provisions within blocks of flats to prevent the build up and storage of combustible rubbish in the common parts. Refuse storage rooms and refuse chutes are therefore normally present in all but the smallest of blocks of flats.

65.2 It is recommended that refuse and chute rooms should:

- ideally be approached directly from the open air or by way of a protected lobby with permanent ventilation

- be separated from all other parts of the building by fire-resisting construction (60-minute fire resistance)
- not be located within protected stairways or protected lobbies.

65.3 However, chute rooms can often be found within stairways, corridors and on balconies on some existing blocks. In these situations, the rooms should be enclosed in fire-resisting construction and have permanent ventilation direct to open air, designed such that the ventilation will not prejudice any escape route in the event of fire.

65.4 Refuse chutes and access hatches can sometimes be found directly opening onto protected corridors, lobbies and stairs, so providing the potential for the spread of fire and smoke to the common escape routes. In these situations, an automatic fire-resisting shutter should be fitted at the base of the refuse chute to restrict the spread of fire and smoke from a fire in the bin room. The shutter should, as a minimum, be operated on a fixed temperature fusible link. Further protection can be provided by a sprinkler system located over the bins, with either frangible bulb or fusible link sprinkler heads, or open sprinkler heads with water discharge controlled by smoke detectors. The provision of sprinklers should always be considered where access hatches open into protected stairways or lobbies containing more than two flat entrance doors.

66. Fire detection and alarm systems

Within flats

66.1 In **all** flats, early warning of fire should be provided by means of smoke alarms installed in accordance with BS 5839-6. A category LD3 system should be considered the minimum in all circumstances. This is a system where there is one or more smoke alarms solely in the circulation spaces of a flat. Flats with more than one level and those with more than one hallway or circulation space will always require more than one smoke alarm. Provision of smoke alarms in flats is discussed further in Appendix 6.

66.2 As stated earlier, more extensive coverage of smoke alarms (and heat alarms in certain rooms) may be an appropriate additional compensatory measure when the escape route design falls far short of acceptable benchmark standards. This is again discussed further in Appendix 6.

Within the common parts

66.3 Fire detection and alarm systems are not normally provided in the common parts of blocks of flats (with the exception of sheltered housing schemes). This has been the benchmark standard for many years (see Appendix 1) and continues to be the case for new blocks of flats under the current guidance in Approved Document B.

66.4 As indicated earlier, there may be circumstances in which such a system needs to be

provided in order to compensate for shortcomings in compartmentation and means of escape.

66.5 In any block of flats where a communal fire alarm system is installed, the system should be of the type to which BS 5839-1 applies. Domestic smoke alarms are not appropriate for the common parts of blocks of flats, nor is it appropriate to apply the recommendations of BS 5839-6 to a communal fire alarm system. Where domestic smoke alarms exist in the common parts of a block, they may, and often should, be removed and replaced (if this is essential) with a fire alarm system of the type to which BS 5839-1 applies.

67. Fire extinguishing appliances

67.1 It is not normally considered necessary to provide fire extinguishers or hose reels in the common parts of blocks of flats. Such equipment should only be used by those trained in its use. It is not considered appropriate or practicable for residents in a block of flats to receive such training.

67.2 In addition, if a fire occurs in a flat, the provision of fire extinguishing appliances in the common parts might encourage the occupants of the flat to enter the common parts to obtain an appliance and return to their flat to fight the fire. Such a procedure is inappropriate.



67.3 Any proposal for the provision of fire extinguishing appliances, or continued presence of existing equipment, should be based only on full justification of the proposal by a fire risk assessment. Where hose reels are currently provided in a block of flats, it is recommended that, subject to consultation with the fire and rescue service, they be removed.

67.4 Notwithstanding the above, it is appropriate to provide portable fire extinguishers in:

- plant rooms and similar ancillary accommodation
- common community facilities
- any staff rooms
- places where people are employed to work and so forth.

In sheltered housing, portable fire extinguishers should be provided in all common facilities, such as:

- laundries and common lounges
- ancillary accommodation
- any commercial premises within the block, such as hairdressers.

However, extinguishers need not be provided within flat corridors.

67.5 This does not preclude residents in any block of flats from providing their own equipment, such as fire blankets or fire extinguishers to tackle a fire in their own flat should they wish to do so.

67.6 Where fire extinguishers are provided, they should be installed in accordance with the recommendations of BS 5306-8.

68. Security locks and access systems

68.1 Ideally, any security locks fitted to flat entrance doors and alternative exit doors from flats should be easily operable by the residents from the inside without the use of a removable key.

68.2 As flat entrance doors are required to be self-closing, there is a risk that any self-locking security devices fitted to the doors could accidentally lock residents outside of their own flats. As well as being a general nuisance for residents who may leave their keys inside the flat, there is also a risk during a fire if residents leave their flat and dependent family members remain inside the flat. The danger in these circumstances is that residents may resort to removing or disconnecting the self-closing device. Flat entrance doors should, where possible, be fitted with a suitable lock that can only be locked on the outside by the use of a key operated deadlock, but that can still be opened from the inside by a handle or lever without the use of a key.

68.3 Residents sometimes also take their own security measures and fit additional locks, and, in some cases, external security grilles and gates to entrance doors and secondary exits. In these situations, residents should be advised of the risks these may present to their safety in the event of a fire within their own flats. Any security locks, grilles or gates should be easily openable without the use of a key at all times. The fitting of these should not impair the effective self-closing of flat entrance doors.

68.4 It might be possible to restrict or prevent the use of external grilles or gates under the terms of the lease, where:

- they do not only present a risk to the individual residents, but impinge on the safety of others (eg if fitted on external balconies used for common escape)

- may delay or prevent access to the fire and rescue service to effect rescues or fight a fire.

68.5 All final exit doors from the building should be easily openable from the inside without the use of a key or code by residents and visitors. A simple turn handle or lever is preferred.

68.6 Any exits fitted with separate electronic locking mechanisms, or such mechanisms which form part of a security access system, must fail-safe on power failure and have a standby power supply. In some situations (including mixed commercial and residential buildings), it might be necessary to consider the provision of suitable override controls in accordance with BS 7273-4.

68.7 When void flats are secured, it is essential that the flat entrance door remains of a type that is fire-resisting and self-closing.

69. Flats in mixed use buildings

69.1 It is important that compartmentation between flats and other occupancies is of a high standard to reduce the risk of fire-spread and to support the 'stay put' policy which should, wherever possible, be adopted for purpose-built blocks of flats. Flats should be separated from other occupancies in mixed-use buildings by walls and floors affording a minimum fire resistance of 60 minutes.

69.2 It is equally important that the common means of escape from flats is suitably protected from the effects of a fire in other occupancies. The common means of escape routes, including corridors, lobbies and stairways, should be separated from other occupancies by fire-resisting construction to ensure the escape routes remain safe to use at all times.



- 69.3 In buildings of four storeys, stairways may serve both flats and other occupancies, provided that the stairways are separated from each occupancy by a protected lobby at each level.
- 69.4 In buildings over four storeys, where the flats are not ancillary to the main use, the flats should be served by an independent alternative escape stairway that is not shared with other occupancies in the building. However, a relaxation that permits a shared stairway may be acceptable in a building where the flats do not form a substantial residential element of the building.
- 69.5 Where a block of flats shares a common escape stairway with, for example, commercial premises below, it is conventional practice to extend the fire alarm system that is present in the commercial premises to cover the flats. This, in effect, would mean that a 'stay put' policy cannot be adopted. Given the disruption this could cause, options for designing or configuring the system to reduce the likelihood that the entire block will need to be evacuated simultaneously should be considered (see Appendix 6).

70. Sheltered housing

- 70.1 Sheltered housing schemes vary in respect of size, design, use and complexity. They can range from a collection of self-contained bungalows or flats, with no on-site facilities or scheme managers, to much larger complexes that may provide communal facilities such as kitchens, laundry rooms, communal lounges and on-site scheme managers.
- 70.2 Although some schemes still have an on-site scheme manager, many rely on on-call systems, through social alarm systems, to provide support to residents. In these cases, there may be only limited day-time cover and no management presence during the night to provide any assistance to the residents in the event of a fire.
- 70.3 Sheltered schemes are designed and constructed on similar lines to purpose-built blocks of flats, with compartment walls and floors and protected escape routes. The principles of a 'stay put' policy apply equally in the same way to sheltered schemes as they do to purpose-built blocks of flats.
- 70.4 In 'extra care' sheltered schemes, some residents may have difficulty in escaping from their own flat without outside assistance. Although this, in many ways, is no different from older persons living in their own home, it does present a particular challenge due to the number of floors and layout of the buildings, and the lack of any management support, particularly during the night.
- 70.5 The limitations of the residents should be taken into account when undertaking assessments in sheltered schemes, and any particular concerns resulting from the vulnerability of any residents should be addressed. However, the recommendations in this guide for sheltered schemes are based on the assumption that residents are able to

escape unaided from their own flats and can make their way to a place of safety using the common means of escape.

Internal means of escape from flats

- 70.6 Rather than provide protected entrance halls with self-closing doors, which can be seen as an obstacle to older residents, planners preferred to design flats with limited travel distances or provide alternative exits, particularly for those flats on the ground level. When assessing the suitability of the existing internal means of escape from the flat, the likely inability of the resident to negotiate self-closing fire doors and use escape doors or escape windows should be carefully considered. This would include any security locks or fastenings fitted to escape doors or windows.
- 70.7 Each flat within a sheltered scheme should be provided with a means of giving warning in the event of a fire in their own flat. Each flat should have a minimum of a Grade D Category LD3 system with smoke alarms in the circulation space or entrance hall. This may need to be extended to a LD2 system, depending on the layout of the flat and the nature of the resident. (See also Appendix 6 with regard to fire alarm systems covering the common parts.)



Common means of escape

- 70.8 In sheltered schemes, the distance of travel from a flat entrance door to a door to a protected stairway, protected lobby or door sub-dividing a corridor should be limited to allow residents to escape unaided. It cannot be assumed that a scheme manager or other persons will be available to render assistance. Residents should not be required to travel far in a smoke-filled corridor to a place of safety, and the current benchmark limits on travel distance should be met in most cases.
- 70.9 Fire-resisting doors, including flat entrance doors, are an important element in the protection of the common means of escape. Although it may be reasonable to accept 'notional FD30' doors in the smaller schemes, in many blocks, it might be more appropriate to provide 'upgraded FD30S' doors as a minimum, albeit as part of a long term programme.
- 70.10 Most older and disabled residents will find it difficult to negotiate self-closing fire doors during everyday use of the building. The fitting of hold open devices, particularly on doors within the horizontal circulation spaces and in communal areas, should be considered.
- 70.11 Many older and disabled residents will find it difficult to use stairs in the event of a fire, and additional measures may need to be considered. These could include temporary safe refuge areas or spaces within existing protected lobbies and stairs. If lifts are provided, where reasonably practicable, consideration should be given to the provision of evacuation lifts that residents may use in the event of a fire.
- 70.12 All communal facilities – such as kitchens, lounges, laundry rooms and any plant or service room – should, where necessary, be separated from common escape routes including corridors and stairways. They should have 30-minute fire-resisting partitions and fire-resisting doors. High-hazard rooms should be separated from stairways by a protected lobby.
- 70.13 Adequate means of escape should be provided from communal areas, such as a lounge, which, ideally, should have one exit leading direct to open air. Any furniture or soft furnishings provided in the common parts should be subject to a risk assessment.

71. Fire-fighting facilities

71.1 Fire-fighting facilities are required in certain blocks of flats to assist the fire and rescue service for the safety of life.

71.2 These facilities may include:

- vehicle access for fire appliances
- access for fire-fighting personnel
- fire mains within buildings
- venting of heat and smoke from basement areas.

71.3 In small blocks of flats, it is usually only necessary to ensure vehicle access is adequate, and that some means of smoke control is available. In taller blocks facilities – such as fire mains, fire-fighting shafts and fire-fighting lifts – may be required.

71.4 In other than very unusual circumstances, there should be no requirement to provide fire-fighting facilities in an existing block of flats or upgrade any facilities if these were not required at the time of construction to comply with the standards of the day.

71.5 The current benchmark design guidance for fire-fighting facilities for new blocks of flats is as follows.

- In blocks of flats without an internal fire main, there should be vehicle access for a fire appliance to within 45m of all points within each flat. In previous guidance, this distance was 60m.
- In blocks of flats fitted with a fire main, all points within each flat should be within 60m of a landing valve on the fire main in a fire-fighting shaft (45m if the landing valve is in a protected stairway).
- Flats over 18m in height should be provided with a fire-fighting shaft, consisting of a fire-fighting stairway and a fire main located in the stairway, and a fire-fighting lift. The fire-fighting lift can, in blocks of flats, open into the common corridor giving access to the flat entrance doors, providing the lift doors are no more than 7.5m from the door to the stairway.

71.7 In existing blocks of flats, the fire-fighting facilities may not be in accordance with the above. In these circumstances, the advice of the fire and rescue service may need to be sought, as it may not be possible, or even appropriate, to consider upgrades to meet current benchmarks. What is important is that the facilities provided should, at least, meet the standard of the day when the block was built and that these should be maintained in efficient working order.

Figure 13 – Basic components of a fire-fighting shaft

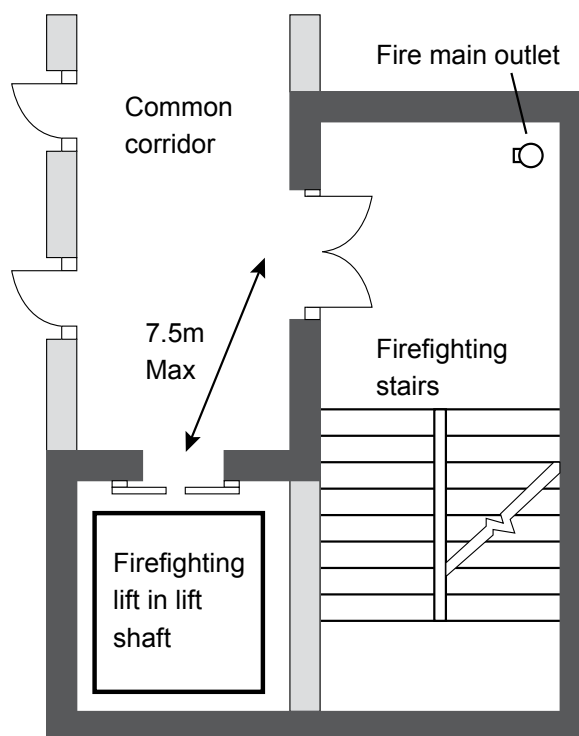

- Minimum fire resistance 60 minutes from both sides with 30 minute fire doors
- Minimum fire resistance 120 minutes from accomodation side and 60 minutes from the shaft with 60 minutes fire doors

Smoke control arrangements not shown

72. External fire-spread

72.1 The external façades of blocks of flats should not provide potential for extensive fire-spread. When assessing existing blocks of flats, particular attention should be given to any rainscreen or other external cladding system that has been applied and to façades that have been replaced.

72.2 The use of combustible cladding materials and extensive cavities can present a risk, particularly in high-rise blocks. Restrictions are normally applied to the nature of such materials and in particular their surface spread of flame characteristics. Cavity barriers are also required in some circumstances. Assistance from specialists may be required to determine if the external surfaces of walls are satisfactory and whether there is adequate provision of cavity barriers.

Part G: Managing fire risk – ongoing control

Key points

- Arrangements for managing fire safety in a block of flats should include the following.
- Developing a fire policy and appointing someone in the organisation to take overall responsibility for fire safety.
- Making sure someone is designated to provide guidance on fire safety measures required by the FSO, and supporting this person with help from specialists, where necessary.
- Coordinating and cooperating with other occupiers, particularly on issues such as fire procedures.
- Using residents' handbooks, websites and other media to engage with residents and communicate vital fire safety messages.
- Providing generic training to ensure housing officers and others visiting blocks of flats have sufficient fire safety awareness.
- Preparing relevant fire procedures and making everyone aware of them.
- Managing the risk from building works, including adopting a 'hot work' permit system.
- Putting in place programmes for routine inspection, testing, servicing and maintenance of fire safety systems and equipment.
- Arranging similar programmes to monitor the condition of other fire safety measures, such as fire-resisting doors.
- Monitoring the common parts through formal inspections, and as part of day-to-day activities by staff.
- Carrying out fire risk assessment reviews to monitor standards.
- Putting in place processes for scrutinising planned alterations in order to consider their impact on fire safety.
- Maintaining suitable records.
- Liaising with the fire and rescue service and encouraging residents to take up the offer of home fire-safety checks.

73. Introduction

73.1 Whatever physical fire safety measures are provided in blocks of flats to ensure a suitable standard of safety, their effectiveness will only be as good as their management and maintenance. Guidance on fire safety management in buildings is contained in BS 9999. There is also guidance in the HM Government guide 'Fire safety risk assessment: sleeping accommodation'. The recommendations in these documents apply equally to the common parts of blocks of flats. However, given the relatively simple nature of a block of flats, many will not be relevant.

73.2 Indeed, there are several fundamental differences between blocks of flats and many other types of building that impact on how fire safety can, and should be, managed. These include:

- there is usually no-one on the premises to manage fire safety on a day-to-day basis
- the response to a fire in a block of flats where the evacuation strategy is to 'stay put' contrasts with the immediate or progressive evacuation of the occupants in most other buildings
- parts of the building may be under different ownership eg leasehold flats
- landlords and others responsible for fire safety have limited control over the activities of tenants within their flats, and even less over leaseholders
- access to flats may not be possible and, even where entry can be gained, restrictions may apply
- residents are usually a disparate group with no common allegiance – it cannot be expected that they would respond or behave like the occupants of other types of residential accommodation, such as hotels and halls of residence
- the level of fire safety knowledge of residents will be variable and rely upon voluntary cooperation in embracing fire safety initiatives.

73.3 Those responsible for ensuring adequate fire safety in blocks of flats and managing this on an ongoing basis can include owners, providers and managing agents. Also included in this are:

- social landlords, such as local authorities and housing associations
- private rented sector landlords
- resident management companies established by residents
- As discussed in Part C of this guide, all are responsible persons under the FSO and all have obligations in this regard under the law.

73.4 Residents also have their part to play. In addition to communicating the fire prevention message (see Part E), is a fundamental element of ongoing control over fire safety to

engage with residents, to explain what fire protection there is in the building and how they can ensure it remains effective.

73.5 Fire risk assessors and enforcing authorities must understand what is achievable by management and be realistic in their expectations. Although circumstances will differ, it would, for example, normally be inappropriate to relax other fire safety measures in the building on the assumption that a high level of management will be in place.

73.6 Equally, in stipulating certain fire safety measures, such as communal fire alarm systems, there will be a consequent level of management needed. This may or may not be possible, and solutions to fire safety should avoid placing unrealistic burdens on management.

73.7 There are minimum requirements for fire safety management that should be achieved in order for the standard of fire safety to be maintained at an adequate level. These, along with examples of good practice, are discussed below.

74. Responsibility for fire safety in the building

74.1 Although there will not necessarily be anyone on site to manage fire safety on a day-by-day basis, it is important that there is someone within the organisation, whatever its size, who has overall responsibility for fire safety. It is common in larger organisations for this to be split. For example, estates maintenance teams may be responsible for repairs and routine testing and inspection of fire safety measures, with the letting department responsible for ensuring that residents understand the conditions applying to alterations to their flats and have received fire safety information on taking up occupation. Housing officers may then be responsible for routine inspections of fire safety.

74.2 Where responsibility is shared in this way, it is important that there is someone who has overall control and authority to ensure that everyone's activities are coordinated and nothing is missed.

74.3 All organisations should formalise the roles and responsibilities of those contributing to the management of fire safety. This should form part of a fire safety policy. Such a policy would normally be part of arrangements required by the FSO for the effective planning, organisation, control, monitoring and review of the 'preventive and protective' measures.

75. Access to competent advice on fire safety legislation

75.1 There is a responsibility under the FSO to appoint a competent person to provide safety assistance, ie guidance on the fire safety measures required by the legislation and how they should be implemented.

75.2 However, this does not preclude an organisation obtaining assistance with this from an appropriately qualified and experienced consultant, or another suitable source, to support the person in fulfilling this role. Anyone providing this service to a responsible person must be fully familiar with fire safety requirements in purpose-built blocks of flats.

76. Coordination with other occupiers

76.1 The FSO also imposes duties on a responsible person to “coordinate and cooperate” with other responsible persons, either located in the same building or having responsibility for fire safety measures in the block. This may apply where the block of flats is part of a development with shops, hotels and other commercial premises, unless there is substantial fire separation between the two and there are no shared escape routes.

76.2 A key element of this is coordination of fire procedures. However, it does not imply that, simply because the flats are in a mixed-use building, a ‘stay put’ policy will not be appropriate.

76.3 The difficulties that can arise when a building or its fire safety systems are shared do need to be recognised. For example, the detectors needed to operate AOVs in the lobbies to stairways may be part of a fire alarm system covering commercial areas. As the system is common to both, it is important that a single organisation takes responsibility for its testing and maintenance and that there is adequate recourse in contracts and leases to take action if there is a failing on this organisation’s part to effect this.

77. Engaging with residents

77.1 Landlords and others responsible for managing blocks of flats should seek to engage with residents and communicate a number of vital fire safety messages, including:

- how they can prevent fires in their own home and in the common parts
- the importance of maintaining their block secure (making sure doors close behind them when they enter or leave) and being vigilant for deliberate fire setting
- that they should never store or use petrol, bottled gas, paraffin heaters or other flammable materials in their flats, on their balcony or in shared areas
- what action they should take if they discover a fire
- how they can ensure they can make their way safely from their flats and how to exit the building once they have left their flat
- what ‘stay put’ means if there is a fire elsewhere in the building
- what they must do to safeguard communal escape routes, especially taking care to make sure fire doors self-close properly and are not wedged, tied or otherwise held open

- what the policy on the use of common parts requires of them
- how they can avoid inadvertently damaging the building's fire protection when making changes to their flat
- when and how they should use fire extinguishers and other fire-fighting equipment, if provided, and why they should not move it or otherwise interfere with it except to use it in an emergency
- what is involved in testing their smoke alarms and how often they should do it
- ways they can assist the fire and rescue service by not blocking access when parking, and by keeping fire main inlets and outlets, where provided, clear
- how they can report essential repairs needed to fire safety measures in their flat and elsewhere in the block.

77.2 Residents' handbooks are traditionally one way to communicate basic fire safety advice to new residents in rented accommodation. Similarly, many organisations use their website to convey information of this nature to their tenants. Where appropriate, and subject to the policy on use of the common parts, this can be reinforced with notices displayed in the building. This may include the findings of the fire risk assessment.

77.3 However, specifically targeted campaigns of leafleting and other initiatives to promote fire safety may be necessary to keep the message fresh in people's minds, up to date and relevant to their particular circumstances. The fire and rescue service can assist with this, joining with landlords, other responsible persons and other agencies on initiatives to offer free home fire-safety checks to residents.

77.4 General advice to give to residents on domestic fire safety and preventing fires in the home is available from <http://firekills.direct.gov.uk/index.html>. 'Protect yourself in your rented home', which is guidance on electrical safety, is also available, in both printed and online form, from the Electrical Safety Council.

It is important that the needs of non-English speaking residents are taken into account. Fire safety information in a number of alternative languages is available to download from www.direct.gov.uk/en/HomeAndCommunity/InYourHome/FireSafety.

Appendix 4 to this guide also contains suitable content for basic advice to include when communicating with residents. Basic fire action notices are usually the simplest means of conveying to residents the actions they should take in the event of a fire.

77.5 Appendix 5 contains templates for simple fire action notices applicable both to situations where a 'stay put' policy applies and situations where – by virtue of a communal fire alarm system – a simultaneous evacuation strategy applies.

77.6 In blocks of flats with communal fire alarm systems, such as many sheltered schemes, it is particularly important that residents understand:

- how to respond to fire alarms in their own flats
- what is expected of them if the alarm sounds in the common parts
- why they should not interfere with the fire alarm system, for example to silence the alarm.

It is vital that they have a means to contact someone from the organisation who can respond quickly if the system is activated when there is no scheme manager, caretaker or other person responsible for the system on the premises at the time. This should be displayed prominently by the fire alarm panel.

78. Instruction, training and information for non-residents

78.1 Caretakers, housing officers and others working in, or visiting, blocks of flats need to be provided with instruction, training and information relating to the fire safety measures in the building and the procedures they should follow in the event of fire. This should relate to the activities they undertake.

78.2 It is, however, important that the extent of such training and instruction, and the scope of the information provided, should reflect the relatively simple nature of these buildings and the limited fire safety measures present. Blocks of flats are far simpler than many other residential buildings and often have simple means of escape.

78.3 For most employees, all that is required is basic fire awareness training. This will need to ensure that they:

- are aware of fire hazards that might be encountered in their workplace, and in the common parts
- know how to prevent fires
- recognise the importance of good housekeeping
- know when and how to use fire extinguishers and other fire-fighting equipment
- understand what to do if they discover a fire
- know how to escape from the building should they encounter a fire
- are aware of how their actions might adversely affect the fire safety measures present in the building, eg by propping open fire doors
- are able to spot obvious deficiencies in fire safety measures eg a damaged fire door.

- 78.4 They need to receive this as soon as they start work for the organisation. It should be repeated at appropriate intervals to ensure people remain vigilant and prepared. Many of those visiting blocks of flats in the course of their duties can be expected to have received this basic fire awareness training at their normal place of work.
- 78.5 More extensive training will be required for scheme managers and other staff with a role to play in responding to alarms and managing evacuations in sheltered housing schemes. It is important that they are fully conversant with the fire procedures in the emergency plan (see below).
- 78.6 While fire drills and practice evacuations are used in many buildings to reinforce fire awareness training, it is neither practical nor necessary to carry them out in purpose-built blocks of flats. Even in blocks with communal fire alarm systems, this is unrealistic. In large sheltered housing schemes incorporating extensive communal amenities, such as hairdressers, cafeterias and shops, fire drills may be necessary. However, these will still only apply to people present in the common parts. Residents within their flats would not be expected to take part in fire drills.
- 78.7 Employees and others working in offices, workshops and other accommodation that may be present in the same building as the flats would be expected to receive appropriate instruction and training and, where necessary, to take part in fire drills. Suitable guidance on this can be found in the HM Government guide 'Fire safety risk assessment, offices and shops'.
- 78.8 Additional training may be required where in-house staff monitor fire safety as part of routine visits and inspections. Those tasked with carrying out and/or reviewing fire risk assessments will need appropriate training to ensure satisfactory competence.

79. Preparing for emergencies

- 79.1 It is a requirement of the FSO that there should be a suitable emergency plan for the premises. Rarely, in purpose-built blocks of flats, will it be necessary to have a more elaborate emergency plan than a simple fire action notice (see Appendix 5 for examples). Nor will it be universally necessary to display such notices. Indeed, it is more common not to display notices, but to convey this information to tenants in other ways (eg through residents' handbooks and so forth).
- 79.2 Where fire action notices are displayed, they must be relevant. Standard fire action notices often refer to using fire extinguishers, raising the alarm by breaking a fire alarm call point and, once outside of the building, gathering at an assembly point. Most blocks of flats have neither a fire alarm system nor fire extinguishers, and, given the 'stay put' policy that should be adopted in most blocks of flats, assembly at a designated place serves little purpose.

79.3 Most standard fire action notices also advise people not to use lifts in a fire. This again will not be relevant if there is no lift in the block.

79.4 If a fire action notice is to be displayed, it would be good practice to place it in a location where it will be viewed routinely by people entering the building eg by the main entrance or, where relevant, by the controls inside a lift.

79.5 In the case of 'general needs' blocks of flats provided with communal fire alarm systems, the fire action notice should reflect the presence of this system and clearly state the action required of residents in response to an alarm. There should be contact details so that residents can arrange for the system to be silenced and reset as quickly as possible in the event of a false alarm. It is vital that this response is as short as possible – any longer than a few minutes could result in residents interfering with the system in an effort to stop the noise of the alarm sounding and re-enter their flats.

79.6 This will apply equally to sheltered housing schemes. Many of these schemes do not have scheme managers or other people on site all of the time ready to respond to activations of the fire alarm system.

79.7 In these buildings, emergency plans will need to be more detailed. The role of scheme managers and others in responding to fire alarm activations received from flats through the social alarm system needs to be clearly defined. Particular consideration should be given to the associated risks from entry into a flat where there might be a fire.

79.8 The role of scheme manager and others in assisting with the rescue of the occupants of flats also needs to be considered. Whether through physical or mental disability, some residents may have difficulty in leaving their flat quickly. A resident's needs for support are usually assessed when they take up occupation, and this should include their ability to escape unaided in a fire. As with other aspects related to their welfare, this should be reviewed as a matter of course as a person's circumstances change.

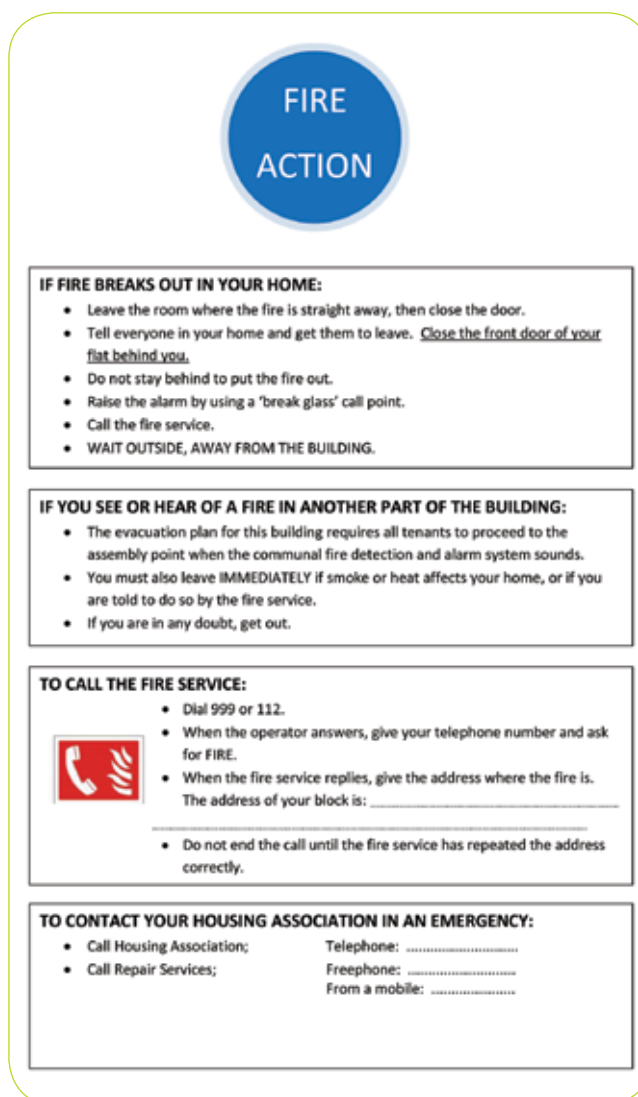

79.9 In 'general needs' blocks of flats, it can equally be expected that a resident's physical and mental ability will vary. It is usually unrealistic to expect landlords and other responsible persons to plan for this or to have in place special arrangements, such as 'personal emergency evacuation plans'. Such plans rely on the presence of staff or others available to assist the person to escape in a fire.

79.10 Even in sheltered housing schemes, there will be reliance ultimately on rescue by the fire and rescue service in the event that residents cannot escape by themselves. However, in sheltered housing schemes, it is commonplace to hold information relating to any resident with particular mobility or other issues affecting their ability to escape. This can be made available to the fire and rescue service on arrival at the premises (eg by keeping it in a 'premises information box', which can only be unlocked by the fire and rescue service, at the main entrance). Details of any residents using oxygen or other medical gases are also usually kept with this information.

79.11 It is not realistic to expect such an approach to be adopted where there are disabled people and others requiring assistance in a 'general needs' block. Any attempts to keep information of this kind must be updated regularly as inaccurate information could potentially be more harmful than no information.

79.12 In large, more complex blocks of flats, it can be of great assistance to the fire and rescue service to keep plans on the premises detailing information on the layout of the building and its services. This can be helpful at the time of an incident in dealing with the emergency. Again, use of a 'premises information box' at the main entrance is one way to achieve this.



80. Controlling hazardous activities

- 80.1 Unlike many other types of building, there are few activities that take place within the common parts of block of flats that are inherently hazardous. The exception is building and engineering works, whether alterations or repairs.
- 80.2 Irrespective of whether they are undertaken by in-house personnel or a contractor, there is potential during such works, not only to start fires or create new hazards, but also to impair fire safety measures, even if only temporarily.
- 80.3 Landlords and other responsible persons should place strict obligations on those undertaking works to implement appropriate fire precautions when carrying out works and to avoid issues such as those above. Incorporating conditions within contracts is one common means of achieving this, but this should also be reinforced by scrutiny of method statements and by inspections during the course of the works.
- 80.4 This is often applied rigorously to major projects, but less so in the case of small works and maintenance. However, the latter may still involve the potential to create hazards and it is important that account is taken of this.
- 80.5 Of most concern is the potential for fires to be started when 'hot work' is undertaken. It is vital that control is exercised over such works. Usually, this is achieved by adopting a 'permit to work' system. This places obligations on those carrying out the work to inspect the areas in which work is taking place – both before and after the work – and to take all necessary precautions, including provision of accessible fire extinguishers.

Examples of new hazards or impairments to fire safety measures that can arise from building works include:

- Making holes in compartment walls and floors.
- Removing stairway doors required to protect the escape routes in order to allow free access for delivering materials.
- Parking over fire hydrants.
- Placing site huts too close to the building.
- Leaving gas cylinders inside the building overnight to avoid having to store them properly away from the building.
- Blocking access to a fire main inlet.
- Leaving combustible building materials in common parts.
- Opening up parts of the structure without providing suitable fire resistant hoarding to separate work areas from occupied parts.

80.6 Further advice on fire safety during construction work is available from the Health and Safety Executive (HSE) and the Fire Protection Association (FPA).

81. Inspection, testing and maintenance of fire safety systems and equipment

81.1 All fire safety systems and equipment need to be maintained in effective working order. It is therefore necessary to have in place arrangements for routine inspection, testing, servicing and maintenance.

81.2 Some of the inspection and testing can be carried out by in-house staff, provided they are suitably competent. However, it is anticipated that most landlords and other responsible persons will need to employ suitable contractors to carry this out. Again, it is essential that these contractors are competent. Various third party certification and approval schemes are available that provide landlords and other responsible persons with confidence that listed companies have been assessed initially in relation to their capability against a recognised standard, and that this is continually monitored through surveillance visits.

81.3 Where elements of the testing are carried out by in-house staff or other non-specialists, it is important that there is access to a suitable contractor to follow up and address deficiencies identified through the testing. In particular it is important to attend site at short notice to carry out emergency repairs resulting from the tests eg in the event that a smoke vent will not close or a fire alarm system will not reset.

81.4 The following details the basic requirements for routine attention in relation to the various fire safety systems and equipment commonly found in purpose-built blocks of flats.

Emergency escape lighting

81.5 Unless the emergency lighting is of the self-testing type, there will be a need to test each fitting periodically. In most cases, the testing involved comprises the following.

- A monthly, functional test using a suitable test facility – the purpose of this is simply to establish by switching from the normal to the standby supply that the fitting has not failed. This is a quick, simple test that can easily be undertaken by, for example, housing officers, or indeed as part of value added service from contractors who visit regularly.
- A full duration discharge test once a year – the purpose of this is to confirm that the batteries are still capable of supplying the fitting for long enough.

81.6 Care should be taken not to leave a building entirely without escape lighting while batteries recharge after a test.

81.7 Further guidance on testing and servicing emergency escape-lighting systems can be found in BS 5266-8.

Smoke ventilation

81.8 Systems of automatically opening vents, or vents electrically controlled but manually operated, should be subject to routine testing and periodic servicing. AOVs and electrically operated OVVs should be tested once a month for correct operation using the manual controls provided. Again this is a simple test that can be undertaken readily by non-specialists.

81.9 Testing smoke detectors and controls associated with AOVs should take place at least once a year, and in accordance with the manufacturer's instructions.

81.10 Other systems of smoke control – including smoke extract systems and pressurisation systems – should again be tested and serviced periodically in accordance with the manufacturer's instructions. This will normally be at least annually, but may involve monthly or more frequent functional tests where the systems are intended to protect the means of escape. It is important that those servicing such systems are familiar with the fire engineering performance parameters used in the design of the system.

81.11 Further guidance on testing and servicing of smoke control systems can be found in BS 9999.

Fire extinguishing appliances

81.12 Where fire extinguishers and fire blankets are provided, they should be inspected and maintained every 12 months. This is a task for suitably trained specialists. However, there is a role for others, such as housing officers, to be alert to any missing or damaged equipment as part of normal walk-rounds or formal fire safety inspections and to report this for action.

81.13 Further guidance on inspection and maintenance of fire extinguishing appliances can be found in BS 5306-3.

Fire detection and alarm systems

81.14 Where provided, fire alarm systems should be subject to routine testing and servicing. There are two parts to this, regular testing and periodic servicing.

81.15 A simple functional test should be undertaken, once a week, by operating a manual call point. This can readily be carried out by non-specialists eg housing officers and in-house maintenance teams. The aim of this test is simply to check that the system is functional. It is not intended that this test be used to confirm audibility of the alarm, for example. However, where operation of this system is associated with, say, release of devices holding open fire doors, or releasing electrically locked fire exits (where

permitted), the weekly test should be used to check the function of these ancillary actions.

81.16 Periodic servicing should be undertaken at least once every six months.

81.17 Further guidance on testing and servicing of fire alarm systems can be found in BS 5839-1.

Smoke and heat alarms

81.18 The need for regular testing applies equally to the smoke alarms and other devices provided for early warning of fire within the flats themselves.

81.19 Rarely are landlords in a position to undertake this on behalf of tenants, and it is usually the responsibility of residents to test their smoke alarms. However, landlords should use opportunities that arise to check on the condition of smoke alarms they have provided. For example, anyone needing to visit a flat can easily check for signs that a tenant has interfered with a smoke alarm or otherwise disabled it. Damage to the device and evidence of battery removal can often be readily visible. In addition, a test of a smoke alarm could be a value added service carried out by any contractor undertaking a routine visit for the purposes of carrying out a repair or, for example, during annual gas safety checks.

81.20 Further guidance on testing smoke alarms can be found in BS 5839-6.

Fire dampers

81.21 Fire dampers, where provided in communal ductwork or rubbish chutes, should be subject to inspection and test periodically to ensure that they will still operate in a fire. Depending on ease of access, this should be undertaken at least once every two years for those operated by fusible links. For those that are spring operated, this should take place every year.

81.22 Further guidance on testing of fire dampers can be found in BS 9999.

Sprinklers (and other fire extinguishing and suppression systems)

81.23 Sprinkler systems and water mist systems, where provided, should be regularly tested and serviced periodically. It is unlikely that a landlord will have staff with appropriate specialist knowledge in-house. Suitable contractors will need to be employed. Further guidance on testing and servicing of sprinkler systems can be found in BS EN 12845 or, in the case of domestic sprinklers, BS 9251. Further guidance on testing and servicing of water mist systems can be found in DD 8489-1 and, in the case of domestic water mist systems, DD 8485-1.

Fire mains

- 81.24 Fire mains need to be inspected every six months and tested every 12 months. Inspections largely involve simple checks to confirm that the outlets are not damaged and padlocks and straps on the landing valves are still in place. This could readily be incorporated within formal fire safety inspections or fire risk assessment reviews. Testing will involve pressurising the main, and will, therefore, normally require a specialist contractor to carry it out.
- 81.25 Further guidance on testing and maintenance of fire mains can be found in BS 9990.

Fire-fighting lifts

- 81.26 Lifts used for fire-fighting need to be subject to tests and maintenance on a regular basis. This will involve weekly operation of override switches and monthly inspections and annual testing and maintenance of the lifts.
- 81.27 Further guidance on testing and servicing of fire-fighting lifts can be found in BS 9999.

82. Inspections and repairs of other fire safety measures.

- 82.1 Other fire safety measures such as fire-resisting doors need also to be maintained. The following details the basic requirements for routine attention in relation to these measures.

Fire-resisting doors

- 82.3 Good practice is to inspect timber fire-resisting doorsets on a six monthly basis as part of a programme of planned preventive maintenance. These inspections are aimed at identifying defects such as:
- missing or ineffective self-closing devices
 - damaged doors or frames
 - removal of locks without suitable repairs to the integrity of the doors
 - poorly fitting doors caused by distortion or shrinkage, or as a result of wear and tear
 - newly fitted, but inappropriate, door furniture
 - doors which have been replaced using non-fire-resisting types.
- 82.4 Flat entrance doors should be included within this programme. Where leasehold flats are involved, this will only be possible if there is legal right of access, by means of a condition within the lease to carry this out. It is important that any new leases include such a condition.

82.5 The defects highlighted above will often be obvious to those carrying out fire safety inspections and, indeed, it is straightforward to train others to be alert to them. Where defects are reported, it is important that action is taken within an appropriate timescale and that they are not simply left to the next six-monthly inspection.

82.6 Further advice on routine inspection and maintenance of fire-resisting doors can be found in BS 8214.

Fire-separating construction

82.7 Routine inspection of fire-resisting walls and floors cannot be so readily achieved. Nevertheless, damage to walls or signs of unauthorised work – including DIY by residents – are likely to be obvious when within the common corridors, lobbies and stairways. Fire safety inspections and fire risk assessment reviews also offer opportunities to inspect other areas such as riser cupboards, plant rooms and so forth.



82.8 Other opportunities, such as when flats become vacant or change tenancy, should be used to inspect the condition of compartmentation and to undertake fire safety improvements.

External fire escape routes

82.9 Where external routes, particularly involving metal escape stairways, are part of the means of escape, they should be subject to periodic inspection and maintenance. Fire safety inspections should include visual checks to look for:

- evidence of damage or corrosion
- build-up of moss or other slip hazards
- trip hazards or obstructions on the stairway.

82.10 Survey by a specialist, at least once every three years, should also be included to ensure that the stairway still has suitable structural integrity.



Manually openable smoke vents

82.11 Windows and other non-electrical means provided for venting smoke should be opened on a regular basis (eg at least once a year), to ensure that they open freely and have not become stuck.

83. Monitoring the common parts and being alert to new hazards

83.1 A formal fire safety inspection of a block of flats is a common means of identifying issues relating to fire prevention and maintenance of fire safety measures. However, many of the day-to-day activities that take place in a block of flats provide continual opportunities to monitor fire safety in the common parts. Ensuring that housing officers, repair teams, cleaners and any other staff or regular contractors are aware of what to look out for can significantly impact on the standard found in a particular building. Scheme managers and care providers are also well placed to undertake this in sheltered housing schemes.

83.2 The extent to which formal fire safety inspections need to be carried out will vary. It depends on how successfully standards are being maintained. However, frequent inspections are likely to be necessary in blocks where there are particular concerns over anti-social behaviour and the consequent threat of arson, or where a 'managed use'

policy applies to the use of the common parts.

83.4 Those undertaking inspections should also be alert to new hazards that might arise from time to time eg use of extension leads from flats to charge a mobility scooter brought in by a visitor.

84. Reviewing and auditing fire safety standards

84.1 There is an obligation under the FSO to review the fire risk assessment. Many organisations also undertake audits as part of the process of ensuring compliance with their legal obligations and demonstrating due diligence in the management of their housing stock.

84.2 Audits and formal reviews need not take place every time there is a change of resident. Nor, indeed, will it be necessary to do so every time minor works take place. Good practice is to encourage a process of dynamic risk assessment by all those responsible for fire safety. This way, people continuously think about fire safety during their work activities.

84.3 However, periodically, and where warranted by the nature of the changes that have taken place, a formal review needs to be carried out and should be recorded. Periodic reviews should always include consideration of the action undertaken in response to the previous risk assessment.

Checklists for fire safety inspections should confirm that:

- combustible waste or storage is not present in corridors, lobbies, stairways and chute rooms
- any notice boards are not overflowing with outdated messages and posters
- other infringements of the policy on the use of the common parts are not taking place
- doors to residents' store rooms, electrical cupboards, plant rooms, bin stores and other ancillary rooms are not being left or held open
- front doors and other entrance and exit doors are closing properly
- where provided, fire extinguishing appliances are not missing, discharged or damaged
- there are no signs of damage to fire-resisting walls, doors and glazing between flats and the common parts
- vents required for smoke control have not been tampered with, forced open and damaged (eg by residents seeking to air stuffy atmospheres or to remove the smell from illicit smoking) or blocked up to prevent draughts
- fire exit signs or fire action notices are not missing or defaced

- where provided, fire detectors, call points and sounders are still in place and have not been damaged, covered over or interfered with in anyway
- fire main outlets, where provided, are not damaged or obstructed
- emergency light fittings are working normally eg illuminated signs are still lit.

85. Controlling alterations so that they are not detrimental to fire safety

85.1 Alterations and improvements to blocks of flats can be detrimental to fire safety if careful thought is not given to the possible impact they might have. Problems can arise, not only when large-scale refurbishment programmes are carried out, but also during minor work that residents themselves might undertake.

85.2 Processes should be in place for landlords and other responsible persons to scrutinise alterations and building work within common parts that could have an effect on fire safety in the block. It is important that Building Regulations approval is obtained where relevant.

85.3 Tenancy agreements should also restrict the works that tenants can undertake within flats without first seeking permission. Leaseholders should also be suitably constrained from making detrimental changes by virtue of the conditions within their lease.



Examples include:

- a leaseholder changing their flat entrance door, but not replacing it with a suitably fire-resisting and self-closing door
- a resident installing a new bathroom suite, but not ensuring that breaches of riser walls created for new drains are fire-stopped afterwards to maintain fire separation to the common riser
- a resident removing the doors and walls to the kitchen and lounge to create an open-plan living area, but in so doing making all the bedrooms inner rooms, and possibly impairing protection to the common parts.
- a utility company installing new gas supplies to flats and creating the necessary ventilation to gas meters by unprotected openings into common corridors and stairways (pictured above)
- a landlord adding a pitched roof to a flat roofed block without providing suitable cavity barriers
- residents fitting non-condensing tumble dryers with holes through fire walls and doors for vent pipes
- a landlord replacing windows and using sealed units, which cannot be opened to vent smoke from common parts
- a contractor installing a new false ceiling without transfer grilles to allow smoke to reach existing permanent vents
- a landlord undertaking a project to fit rain screen cladding to an existing block of flats without considering the potential for a fire from a flat to travel upwards through the cavity behind the cladding to spread into the flats above
- the installation of downlighters in the ceilings of flats – which are not of a closed back ‘fire-rated’ design and which have not been fitted with intumescent fire hoods or covered by an insulation support box – therefore diminishing the fire separation provided by the ceiling
- a resident undertaking DIY to fit additional socket outlets and, in so doing, damaging the protection to the timber frame construction.

86. Being alert to possibilities of improving fire safety standards

86.1 Alterations and improvements to a block of flats can also provide ideal opportunities to upgrade the fire safety measures, often at minimal extra cost. For example, when lift replacement becomes necessary, specifying that the old standard fireman’s lift be upgraded to current fire-fighting lift standard, particularly in relation to power supplies, will significantly improve the protection afforded to fire-fighters at the time of an incident in the building.

87. Maintaining records

- 87.1 It is good practice to keep records that show that people have received fire training and that inspection, testing and maintenance has been carried out on fire safety systems and equipment. Such records enable a responsible person to demonstrate due diligence in the event that fire safety is found wanting, either as a result of routine audit or following scrutiny after a fire.
- 87.2 Various methods can be used to keep records, from the commonly-used log book to electronic devices used to capture data.
- 87.3 In new buildings, there is an obligation under the Building Regulations 2010 to pass on information on the fire safety design to those who have responsibility for managing the building and meeting their obligations under the FSO. This is particularly important where fire engineering has been employed to produce fire safety designs that are not code-compliant. This information is usually contained in a fire safety strategy developed during the building project to support the approval under the Building Regulations.
- 87.4 It is possible that this may have applied to the larger, more complex blocks of flats built recently. However, for most existing blocks of flats, it is unlikely that any such information will have been documented.
- 87.5 There is an obligation under the FSO to maintain records of the fire safety arrangements in a building. This is particularly important so those tasked with managing fire safety are aware of the fire safety features incorporated within the design of the building. It is important so that fire safety measures can be suitably maintained on an ongoing basis. It also enables landlords and other responsible persons to ensure that these measures are preserved and protected during future alterations to the building.
- 87.6 A record of the fire safety arrangements can often take the form of a simple plan of the building showing the various fire safety measures. Such plans might be appropriate for some medium and high-rise blocks of flats but are rarely likely to be warranted for low-rise blocks. In practice, there will be no need for a specific record of the fire safety arrangements in many blocks, particularly if the fire safety measures are detailed sufficiently in the fire risk assessment. Generic policies and procedures covering maintenance arrangements and so forth would then suffice to meet the FSO's requirements in this respect.
- 87.7 In some cases – particularly where the flats are part of a larger mixed-use development, or where fire safety engineering has been incorporated within the design – it might be appropriate to prepare a fire safety manual as a record of the fire safety arrangements. This might also apply in the case of, say, a large extra care sheltered housing scheme – particularly where different organisations are involved in the running of the building and provision of care. Guidance on the content of a fire safety manual can be found in BS 9999.

88. Liaising with agencies responsible for fire safety

88.1 Fire and rescue services routinely undertake visits to certain premises in order for operational crews to become familiar with the features of the building, including:

- the access for fire appliances
- availability of water for fire-fighting
- the provision of any special facilities for their use, such as fire-fighting lifts and fire mains.

88.2 Most blocks of flats would not warrant such a visit, other than possibly in the case of high-rise blocks. However, crews may also visit larger sheltered schemes. Whether a particular block of flats needs to be visited is a matter for the discretion of the local fire and rescue service. Nevertheless, landlords and others with responsibility for the blocks should welcome such visits, as pre-planning for an emergency in this way can be invaluable.

88.3 The fire and rescue service are also able to assist landlords and others responsible for fire safety in reinforcing the fire safety message to residents. Home fire-safety checks are a key component of the 'community fire safety' initiatives of fire and rescue services and are available to residents of any domestic dwelling. Landlords and other responsible persons should use suitable opportunities to draw this to the attention of residents, particularly those with special needs, such as disabled people.

Appendix 1

History of fire safety design standards for purpose-built blocks of flats

- A1.1 To carry out a fire risk assessment for an older block of flats – designed before current guidance on design of measures such as means of escape and smoke control – it is necessary to have some understanding of the original principles on which the block was probably designed. This gives some understanding of whether significant departures from current guidance on the design of a new, purpose-built block of flats have arisen from radical changes in guidance, or from material alterations that compromised the original design and that should, therefore, be rectified (see Figure X in Part F of this guide).
- A1.2 This enables a sympathetic approach to old blocks of flats designed in accordance with superseded standards. It is not appropriate simply to apply current standards to such blocks, with no consideration of the risk to people from continuation of the original fire safety measures without expensive upgrading that is not proportionate to the risk. (By analogy, an old car may not incorporate all the safety features of current models, but may still meet road traffic legislation.) Requirements for upgrading fire safety measures in such circumstances should be based on identification of material risk, rather than prescriptive application of current guidance.
- A1.3 General guidance on the relevant legislation and design principles that were typically adopted at various periods of time are outlined below, along with the relevant superseded codes of practice, which can often be consulted to obtain further detail. Many of the codes of practice to which this appendix refers are lengthy and detailed. They can only be briefly summarised in this guide.

Pre 20th-century blocks of flats

- A1.4 Flats built before the 20th century may well have been constructed in accordance with local legislation and bye-laws. In the Victorian era, mansion-style blocks of flats were constructed for upper-class people, and tenement blocks were constructed for working-class people.
- A1.5 Typically, these blocks may comprise a single stairway of four or five storeys, with flats entered directly from the stairway, or blocks with corridors, often of considerable length, with or without alternative stairways for means of escape from fire. In early tenements, construction may have originally incorporated lath and plaster ceilings and timber floors, which would, by today's standards, not provide sufficient fire resistance between storeys.



A1.6 However, lath and plaster ceilings may have been replaced with plasterboard that would afford a reasonable degree of fire resistance, and concrete floors often exist in mansion blocks constructed in the latter half of the 19th century. Endeavours should be made – to the extent practicable – to determine the likely construction of floors and ceilings. A reasonable degree of fire resistance between floors may be adequate to support a ‘stay put’ policy, subject to reasonable protection of the communal means of escape from a fire in a flat or suitable alternative means of escape.

A1.7 In the latter part of the 19th century, very basic measures to support means of escape were sometimes incorporated, such as escape via roofs into adjacent buildings. There may also have been efforts over the years to upgrade means of escape, by provision of alternative escape routes comprising routes over roofs and external stairways.

A1.8 It is important to be aware and consider possible shortcomings in respect of means of escape from these old blocks of flats. Such shortcomings include:

- flats of more than three storeys above ground that are served by a single stairway, with no alternative means of escape and no lobby protection of the stairway
- inadequate fire resistance between each flat and the common parts – particular note should be taken of any glazed fanlights or sidelights, as these are unlikely to afford any significant fire resistance, unless they have been replaced with fire-resisting glazing or fire-resisting secondary glazing within flats
- panelled flat entrance doors, with less than a notional fire resistance of around 20 minutes if tested in accordance with current fire-resistance tests

- flat entrance doors that are not effectively self-closing
- long travel distances along corridors leading to protected stairways, sometimes in a single direction with no alternative escape route
- escape routes onto, and over, roofs, which are often unsuitable for disabled, older or infirm residents, or for young children
- external escape routes, such as walkways or stairways, which may be exposed to a fire in an adjacent flat, may not terminate at a place of ultimate safety, or may be in poor condition.

A1.9 There were not normally any special measures for smoke control in these blocks, and it is usually not reasonably practicable to install such facilities today. However, often there are openable windows within common parts, which are of value to the fire and rescue service for smoke clearance and should normally be maintained in place.

A1.10 Consideration may need to be given to any common shafts for ventilation (eg from kitchens or bathrooms), which may have been added over the years and may not incorporate adequate measures to prevent fire-spread between flats.

Flats built in early part of 20th century

A1.11 These flats were, again, often subject to local bye-laws, produced from time to time over many years, relating to general standards of construction, though not necessarily to means of escape from fire. The Public Health Act 1936 empowered all local authorities in England to make such bye-laws for the construction of buildings and the materials used.

A1.12 The Public Health Act also required local authorities to make such requirements as considered necessary to ensure adequate means of escape from blocks of flats over two storeys and with a floor over 20 foot (ft) above ground level. This sometimes comprised escape routes via roofs or external stairways.

A1.13 The power of local authorities to make bye-laws relating to these matters was withdrawn by the Public Health Act 1961, by which time there were around 1,400 sets of bye-laws. This Act also gave the power to ministers to produce national Building Regulations.

A1.14 In London, the London Building Acts (see below) made requirements for the construction of buildings, and for means of escape from certain blocks of flats. Certain other Acts, specific to particular cities, also made requirements on such matters.

A1.15 None of the above legislation made specific detailed requirements for the design of measures such as means of escape. There were no nationally adopted codes of practice to which reference can now be made until the publication of a British Standard code of practice, 'CP3 chapter IV', in 1948. This code of practice only applied to two-storey blocks of flats. In view of its obsolescence and very restricted scope, it is not

considered further – other than to note that a fire resistance of 30 minutes was specified for construction that separated the lower flats from the stairway to upper flats.

London legislation

A1.16 Locally applicable guidance was produced by some authorities, most notably the London County Council (LCC) in support of their local legislation. LCC produced guidance that applied from 1907-1936, after which it was substantially revised.

London legislation 1936-1946

A1.17 Under the LCC guidance of 1936, a single, non-combustible stairway was acceptable in residential blocks not exceeding four storeys above ground level, with each flat accessed directly from the stairway (or from a protected lobby or corridor).

A1.18 There was a maximum of four flats per storey, where floors were timber and ceilings were plastered, or six flats if the floors were non-combustible and there was a fire-resisting screen and door separating the stairway from any common corridor. It was required that rooms within flats had to be entered from an entrance hall.

A1.19 For blocks exceeding four storeys above ground, or with a floor more than 50ft above ground, an alternative means of escape, independent of the stairway, was necessary. Bedrooms in flats over 50ft in height, or on floors inaccessible to fire and rescue service appliances, had to be entered from an entrance hall or be provided with a pass door to the common parts or an alternative means of escape.

A1.20 In the case of 'block dwellings' (for working class people), access to flats was via open balconies. In these blocks, a single stairway, partly open to the outer air, was acceptable for blocks not exceeding four storeys above ground level (or five storeys if the top two storeys were maisonettes) with accommodation for not more than 150 persons. All dwellings had to have an entrance hall. The maximum distance of travel between any flat and the stairway was limited to 80ft (approximately 24m). For blocks with more than four storeys above ground level, a second stairway was necessary – except that, where there was only one additional storey, access could be provided from each flat to the balcony of the flat below (or, in the case of the upper storey of a maisonette, via a link balcony to the adjacent maisonette).

A1.21 From 1939, (until the current day), Section 20 of the London Buildings Acts (Amendment) Act 1939 has enabled additional requirements to be made in respect of construction of blocks of flats with a storey greater than 100ft (approximately 30m) above ground, or above 80ft (approximately 24m) if the area of the building exceeds 10,000 square feet (approximately 929m²).

A1.22 The requirement for alternative means of escape in the case of buildings with more than four storeys above ground was subsequently applied where any floor was above 42ft (approximately 13m).

London legislation 1946-1962

A1.23 New guidance for flats in London was produced in 1946. The maximum travel distance to a single stairway was increased to 100ft (approximately 30m), or 90ft (approximately 27m) to the nearest stairway in the case of buildings requiring two stairways.

A1.24 The two stairways could be no more than 180ft (approximately 55m) apart, except in the case of open balcony approach, where no limitation applied.

General

A1.25 Where blocks of flats were built prior to 1962, several of the possible shortcomings of which it is important to be aware and consider in respect of means of escape are similar to those previously described for pre-20th-century blocks. However, original flat entrance doors were likely to have been fire-resisting, as defined by the standards of the time. These may continue to afford a reasonable degree of fire resistance, other than in critical situations, such as long dead ends, where upgrading to current standards may be warranted.

A1.26 In the latter part of this period, shunt ducts may have been used to prevent fire-spread between flats via common ventilation shafts, but this may need to be confirmed where there is a 'stay put' policy.

Flats built between 1962 and 1971

A1.27 In 1962, BSI published a new code of practice, 'CP3 chapter IV part 1', which provided recommendations for fire precautions in blocks of flats over 80ft (approximately 24m) in height. The code of practice was also considered appropriate for buildings less than 80ft in height.

A1.28 The 1962 version of 'CP3 chapter IV part 1' was highly significant as it was the first national code to advocate, and incorporate, fire safety measures based on, what is now known as a 'stay put' policy. In 1962 this was expressed as a principle whereby those in flats on floors above that in which a fire occurred would be safe to remain within their own flats. (It was acknowledged that flats on the same floor as the fire, or even in the immediate vicinity of the fire, might need to be evacuated,



but a fire alarm system was not considered necessary.) The fire safety measures recommended were intended to ensure that means of escape remained safe for use by those with a need, or desire, to evacuate the block.

- A1.29 This strategy has proved appropriate over the last half century, and has worked satisfactorily in the vast majority of fires in blocks of flats. Accordingly, it should not readily be abandoned today. Even if a fire alarm system is considered necessary (eg as a result of serious structural shortcomings that cannot be rectified), complete evacuation of a high-rise block of flats in the event of a fire in one flat is unlikely to be appropriate (see also Part F and Appendix 6 of this guide).
- A1.30 The code recommended that all flats have an entrance hall, in which there was no fire hazard. Bedrooms were to either open directly from this entrance hall (and be nearer to the entrance than any door to a living room, dining room or kitchen), or the bedrooms were to have an alternative exit leading directly to a main escape route outside the flat. The living room, dining room and kitchen doors were required to be fire-resisting and self-closing. This often enables identification of a block of flats built in accordance with this early version of 'CP3 chapter IV part 1'. The bedroom doors are often hollow core domestic doors, without any substantial doorstop, whereas the living room and kitchen doors are solid fire doors, closing onto a 25mm stop.
- A1.31 Maisonettes were, in addition, required to have an alternative means of escape from the non-entrance level. If the escape route from any room on the upper level passed the landing at the head of the stairway, a fire-resisting screen with a fire door was required at the head of the stairway to separate the stairway from the upper level. Alternatively, pass doors between rooms, or an internal entrance hall, could be used to protect the upper floor escape route from a fire on the level below.
- A1.32 Where alternative exits from a bedroom were necessary, this could be provided via a balcony leading to a stairway, or via an internal stairway leading to common parts on the floor above or below the bedroom floor.
- A1.33 To facilitate safe escape within the common parts, in the case of flats accessed via balconies, alternative means of escape from each dwelling to a stairway was considered necessary. This normally comprised a balcony leading to a stairway at each end, but alternatively could comprise a balcony at both sides of the block leading to one or more stairways. In the case of maisonettes, these latter balconies could be on alternate floors, so ensuring safe escape from a fire within the maisonette, as well as safe escape from a fire that affected any balcony.
- A1.34 For dwellings with a corridor approach, where every dwelling was provided with an alternative exit to a main stairway (eg via a balcony with escape in two directions), the maximum travel distance from the flat entrance door to a main stairway was limited to 100ft (approximately 30m) and the corridor was to be provided with permanent or openable ventilation.

A1.35 Where an alternative exit was not available from each flat, the maximum distance from any entrance door to the nearest stairway was still limited to 100ft, provided the dwelling was situated between two stairways, or otherwise was limited to 50ft (approximately 15m). In addition, every dwelling had to open into a corridor and:

- i. either be no more than 15ft (approximately 4.5m) from the door to the main stairway (or to a smoke-stop door across the corridor) or not more than 15ft from a permanently ventilated lobby
- ii or open into a permanently ventilated lobby and be not more than 15ft from a smoke-stop door separating the lobby from the corridor leading to the stairway.

A1.36 Where a single stairway was permitted, access to it was either from a balcony or a ventilated lobby.

A1.37 Where common ventilation shafts served flats on each storey, a shunt duct was used to link each flat to the common shaft. Alternatively any horizontal duct from a flat to the shaft was required to be at least 3ft long. In the latter case, the junctions between the horizontal sections from each separate dwelling and the main duct were to be at least one storey apart in height.

A1.38 National Building Regulations, applicable throughout England (other than inner London) were first produced in 1965. These made no requirements for means of escape, but did require compartmentation between flats.

London legislation

A1.39 In 1962, London County Council also published guidance on fire precautions in blocks of flats, in support of the London Building Acts.

A1.40 This guidance required entrance halls within flats. It continued to permit direct access from flats to a single stairway (or to an internal protected lobby or corridor leading to a stairway or to an external balcony leading to an open stairway or partially open stairway) provided no floor was greater than 42ft in height (typically, a block of flats with up to four upper storeys).

A1.41 For blocks with floors over 42ft in height, an alternative means of escape was required, but this could comprise access to the roof (with a screen across the stairway to separate the lower floors from the uppermost floors). From the roof, access was provided to an adjoining building, a balcony or an external stairway. For balcony approach dwellings with only one storey above 42ft, a suitable alternative means of escape comprised a stairway to the balcony below.

A1.42 The maximum distance from a dwelling to a stairway was 100ft (approximately 30m), or, where there were two stairways, 90ft (approximately 27m) and the two stairways were not to be more than 180ft (approximately 55m) apart.

A1.43 Different recommendations applied to blocks accessed via open balconies or ventilated lobbies that connected to enclosed stairways. The recommendations varied according to whether there was only one flat in line from the stairway or more than one flat. In both cases, entrance halls were required within flats and the cross ventilation of the lobby was required. However, in the case of blocks with more than one flat in line from the stairway, alternative means of escape was required from all floors over 80ft (24m) in height.

A1.44 Additional requirements for blocks over 80ft in height were required under Section 20 of the London Building Acts (Amendment) Act 1939.

Flats built between 1971 and 1985

A1.45 In 1971, CP3 chapter IV part 1: 1962 was superseded by CP3 chapter IV part 1: 1971, which provided recommendations for precautions from fire in flats and maisonettes over two storeys. This code of practice was adopted in London for the purpose of compliance with the London Building Acts. However, in the case of tall blocks of flats, to which Section 20 of the London Building Acts (Amendment) Act of 1939 applied, a code of practice produced in support of that legislation specified additional measures, and, more generally, was accepted as an alternative code to CP3 chapter IV part 1 in relation to all the relevant fire precautions.

A1.46 In 1972, the Building Regulations were revised (but were still not applicable in inner London). The Building Regulations 1972 (and all later versions of the Building



Regulations) continued to require compartmentation between flats, and additionally required a protected stairway in blocks of flats of three or more storeys. In addition, reasonable means of escape were required in the case of blocks of flats above 4.5m in height (a traditional three, or more, storey block). 'CP3 chapter IV part 1' was deemed to satisfy a specification for reasonable means of escape. The Building Regulations 1976 continued these requirements (with the additional requirement that the enclosure of the protected stairway must extend to a final exit).

- A1.47 The original 1972 version of 'CP3 chapter IV part 1' was amended in 1972, 1973, 1976 and 1978. None of the first three amendments are of significance for the purpose of this guide. The 1978 amendment reproduces advice to owners and occupiers of flats, originally published in the report of the working group of the Central Fire Brigades' Advisory Councils for England and Wales and for Scotland on Fire safety in high-rise blocks of flats. It is of particular note that the advice to occupiers was that, if a fire is evident or reported elsewhere than their own flat, it will normally be safe to stay within their flat, closing doors and windows.
- A1.48 'CP3 chapter IV part 1' provided numerous options for the design of flats and maisonettes, and, in acknowledging the difficulty of making comprehensive recommendations for every situation, the code of practice advocated intelligent application of its principles and recommendations. As it is still available (from the British Standards Institution), its recommendations are only broadly summarised below.
- A1.49 A number of the principles of the 1962 and 1971 codes are very similar. However, in contrast with the 1962 version, the 1971 version no longer assumed that a whole floor or even adjoining dwellings need be evacuated if a fire occurred in a flat. It was considered that, as a result of the compartmentation in blocks of flats at that time (as a result of requirements under Building Regulations), the spread of fire and smoke from one dwelling to another, and the need to evacuate occupants of adjoining dwellings, was unusual.
- A1.50 A further contrast with the 1962 code relates to the protected entrance halls within flats. Both versions recommended the provision of these entrance halls, but the 1962 version recommended that only the lounge, dining room and kitchen doors need be fire-resisting and self-closing. The 1971 code recommended this for all doors, other than bathrooms and WCs containing no fire hazard.
- A1.51 Bedrooms were to open into an entrance hall and preferably be nearer to the flat entrance door than the living room and kitchen. The bedroom doors were not to be further than 7.5m from the entrance door unless there was an alternative means of escape from the bedrooms, which could comprise a linking balcony to an adjoining flat.

- A1.52 Various layouts for maisonettes were acceptable, but an alternative means of escape was required from every floor on which a habitable room was located, other than the entrance floor. This could comprise a linking balcony to an adjoining dwelling or a stairway to, for example, the corridor on another floor of the block. An open-plan maisonette – in which the upper floor was accessed via a stairway from the lounge – was acceptable provided there was an alternative means of escape from each floor and a protected hallway within the dwelling to protect the common parts from a fire in a room within the dwelling.
- A1.53 For dwellings accessed from a balcony, there was not generally any limit in travel distance to a stairway. Where there was escape only in one direction along the balcony, either there was to be an alternative route to a main stairway or construction below 1,100mm above the balcony floor was to be fire-resisting and unglazed.
- A1.54 In the case of conventional corridor access (without alternative means of escape from the dwellings), two alternative methods of smoke control were specified, as follows.
- A1.55 In smoke containment, the entrance door of every dwelling was to be no more than 4.5m from a door to a fire door to a main stairway, to a fire door across the corridor or to the door to a ventilated lobby. If the design was such that the 4.5m distance was to a cross-corridor door, and any other flat entrance door was located between the cross-corridor door and the stairway, there was to be an alternative means of escape to a further stairway. Alternatively, the flats could open into a ventilated lobby and have entrance doors no further than 4.5m from a door separating the lobby from a corridor that led to a stairway.
- A1.56 In smoke dispersal, reliance was placed on cross-ventilation of the corridor, uninterrupted by cross-corridor doors. The cross-ventilation could be provided by manually opened vents, together with either permanent vents or automatically opening vents operated by smoke detectors. Dead end corridors were limited in length to 15m, but, where there was escape in two directions, the travel distance from a flat entrance door to a stairway could be 40m.
- A1.57 In buildings with a single stairway, the stairway could be entered only from a balcony or a permanently ventilated lobby. However, there was a relaxation for small single stairway buildings of not more than four floors above ground level. In the latter case, if the net floor area of dwellings above first floor did not exceed 380m², the stairway could be entered from an unventilated lobby; this lobby could be omitted from the topmost floor.
- A1.58 Alternatively, if the net floor area of dwellings above first floor did not exceed 720m², the stairway could be entered from lobbies with either permanent ventilation or openable windows.
- A1.59 Stairways in all buildings were required to have either permanent ventilation or openable windows. Where a main stairway was not located against an external wall, or had no opening windows, it was to have a permanent vent at the top.

A1.60 It should be noted that thinking on the subject of smoke control in the common parts of blocks of flats has changed significantly since the publication of 'CP3 chapter IV part 1'. Accordingly, it may be inappropriate to restore original smoke control arrangements that have been undermined (eg by blocking of permanent ventilation because of discomfort to residents) if more suitable smoke control arrangements, in line with current design philosophy, are practicable.

A1.61 In particular, it should be noted that smoke dispersal has been shown to be vulnerable to failure as a result of wind direction, and so may be unreliable. While it might be appropriate to leave in place existing arrangements of this type, maintained as originally designed, it might be less appropriate to engage in capital expenditure to restore such arrangements to their original design, if the expenditure could, instead, provide more effective smoke control in line with modern standards.

Flats built between 1985 and 1992

1.62 The Building Regulations were subject to a major restructuring in 1985 (and applied in Inner London from 1987). Previous editions of the Regulations set out prescriptive technical requirements for the design of fire precautions. The Building Regulations 1985 were cast in 'functional form'. That is to say they contained only 'functional requirements', which in effect are objectives that must be achieved, with flexibility and in general, as to the design of the measures by which the objectives are achieved.



A1.63 One of the functional requirements (Requirement B1) was the provision of means of escape from fire. However, in the case of blocks of flats, this requirement only applied to buildings of three or more storeys, with one or more flats on the second floor or above. Means of escape was only required for people on the second floor or above. This was, in effect, simply a continuation of much of the previous legislative requirements to which this appendix makes reference – in which any requirements for means of escape from flats related to floors more than 20ft (6m) above ground level. On these floors, escape via windows is not generally possible.

A1.64 For compliance with the functional requirement for means of escape from fire, no flexibility was afforded. Instead, there were ‘mandatory rules for means for escape’. No other ways of compliance with the functional requirement were acceptable. The mandatory rules required that the means of escape complied with specified clauses of ‘CP3 chapter IV part 1: 1971’. These clauses included all those concerned with design of means of escape, both within the flats and in the common parts.

A1.65 Given the major changes in recommendations for means of escape from flats contained in later codes of practice, it is to be expected that blocks of flats built before 1992 might well not meet the design principles for means of escape adopted after 1992.

A1.66 Requirement B3 of the Building Regulations 1985 required various structural fire precautions, including compartmentation to limit fire-spread. Non-mandatory guidance on means for compliance with Requirement B3 was given in Approved Document B under the Regulations. This guidance specified that all floors in flats (other than floors within maisonettes) and all walls separating a flat from another part of the building should be constructed as compartment floors and walls, with, in the case of flats in buildings of three or more storeys, at least 60-minute fire resistance.

A1.67 In 1990, ‘CP3 chapter IV part 1’ was superseded by BS 5588-1. However, the mandatory rules on means of escape still referred to CP3 chapter IV part 1 until they were withdrawn in 1992. As BS 5588-1 is still current, it is not considered further in this review of historic standards. However, it is anticipated that BS 5588-1 will be superseded by a new code of practice, BS 9991, during the course of 2011.

Flats built after 1992

A1.68 The mandatory rules for means of escape were withdrawn in 1992, when the Building Regulations 1991 came into force. These Regulations were superseded by the Building Regulations 2000 and then the Building Regulations 2010.

A1.69 From 1992 until the current time, Approved Document B has provided recommendations on compliance with all the fire safety requirements of the Building Regulations. This includes Requirement B1 regarding means of escape from fire, which applies to blocks of any number of storeys and not only to those of three storeys or more. For less common designs, such as flats entered from above or below,

flats containing galleries and flats with balcony or deck approach, Approved Document B refers to the guidance in BS 5588-1.

A1.70 It is anticipated that fire precautions in blocks of flats designed in accordance with the requirements of the 1991 and later Building Regulations will not require any further work to satisfy current legislation, provided the fire precautions approved under the Regulations remain in place and are properly maintained.



A1.71 It should be noted that the need for smoke alarms in new flats first arose from the Building Regulations 1991, though, for compliance with these Regulations, the smoke alarms could be mains powered without a standby supply. The need for smoke alarms to be mains powered with a standby supply first arose in the 2006 edition of Approved Document B. If existing mains operated smoke alarms without a standby supply are replaced, models with a standby supply should be installed. Smoke alarms within the circulation areas of dwellings should be of the optical (rather than ionisation chamber) type.

A1.72 From 2006, Approved Document B no longer specified that there need be alternative means of escape from maisonettes provided that there is a protected entrance hall and either smoke alarms in each habitable room (but a heat alarm in the kitchen) or a sprinkler system. (The smoke alarm option does not apply where the entrance storey to the maisonette and the floors above and below are more than 7.5m vertically apart.)

A1.73 Guidance on smoke control in the common parts of blocks of flats was also changed in 2006. However, it is not expected that these changes be applied retrospectively.

A1.74 The most major change in guidance on blocks of flats since 1992 is the specification in Approved Document B for sprinkler protection of blocks of flats that exceed 30m in height. The sprinklers need only be installed within the flats, but not the common parts. It is recognised that this will, in the future, greatly enhance the safety of residents from fire in high-rise blocks of flats, making a death from fire, even in the flat in which fire starts, unlikely.

Appendix 2

Steps in a fire risk assessment

A2.1 Some guidance – such as that produced by the Department for Communities and Local Government (DCLG) in support of Regulatory Reform (Fire Safety) Order 2005 (the FSO) – suggests five steps in a fire risk assessment.

1. Identify fire hazards (sources of ignition, fuel and oxygen).
2. Identify people at risk (people in and around the premises and people especially at risk).
3. Evaluate the risk of a fire occurring and the risk to people from fire, remove or reduce fire hazards. Remove or reduce the risks to people by means of:
 - detection and warning
 - fire-fighting
 - escape routes
 - lighting
 - signs and notices
 - maintenance.
4. Record significant findings and action taken. Prepare an emergency plan. Inform and instruct relevant people. Cooperate and coordinate with others and provide training.
5. Keep assessment under review and revise where necessary.

A2.2 The British Standards Institution publicly available specification, PAS 79, sets out the following nine steps, which amplify, but do not conflict with, the five steps set out in government guides.

Step 1: Obtain information

- The following information will be relevant, as it has a bearing on fire risk.
- The number of floors below ground and the number of floors above ground.
- The approximate area of each floor.

- Any ancillary uses to which one or more areas of the building is put, such as commercial, community activities, etc.
- The number and nature of the residents. This includes any social and known lifestyle factors that affect the risk from fire. It should be determined as to whether the number of disabled people is likely to be different from a typical, general needs block of flats (eg where housing is specifically provided for disabled people).
- The presence of staff, eg a caretaker, porter or concierge.
- Previous experience of fires.

Step 2: Identify the fire hazards and control measures

A fire hazard is any source, situation or unsafe act that can cause a fire. Fire hazards within the flats and under the control of the residents need not be considered. Consideration should be given to the potential following causes of fire and to measures provided to eliminate or reduce the likelihood of each cause:

- arson
- electrical faults (in fixed wiring and any equipment provided)
- smoking
- use of portable heaters
- contractors' activities
- heating installations
- lightning
- poor housekeeping, including inappropriate storage of refuse and discarded items.

Step 3: Assess likelihood of fire

All that is required is a subjective judgement as to whether, based on the findings of Step 2, there is an untoward likelihood of fire as a result of inadequate control over fire hazards.

Step 4: Determine the fire protection measures

Fire protection measures are design features, systems, equipment or structural measures to reduce danger to people if fire occurs. Principal fire protection measures to consider are as follows.

- The means of escape from fire, with consideration given to:
 - the fire resistance between flats and the common parts
 - flat entrance doors, which should be fire-resisting and self-closing
 - protection of stairways from fire in adjacent areas

- travel distance from flat entrance doors to the nearest stairway or final exit
- means for smoke control within the common parts.
- Emergency escape lighting.
- Fire escape route signs (which are not normally necessary in simple blocks of flats).
- Any fire extinguishing appliances provided (these are not normally necessary).
- Any fire alarm system within the common parts (such a system is not normally necessary, but smoke detectors may be provided to open vents automatically as part of the smoke control measures).
- Compartmentation, particularly the enclosure of flats within fire-resisting construction.
- Any sprinkler installations provided.
- In tall blocks of flats, fire mains and fire-fighting lifts.

The adequacy of the existing fire protection measures should be assessed and any need for improvements should be identified. (Measures to assist the fire and rescue service, such as fire mains and fire-fighting lifts, are not required by the FSO, but will normally have been required under Building Regulations at the time of construction of a tall block of flats. Adequate maintenance of these measures should be verified.)

For discussion of fire protection measures, see Part F of this guide.

Step 5: Obtain information about fire safety management

- Matters to consider include the following:
- responsibility for fire safety in the building
- access to competent advice on fire safety legislation
- the emergency plan, particularly the procedures for residents to follow in the event of fire
- testing and maintenance of fire protection systems and equipment
- documentation of the fire safety arrangements, where this is required
- training of any persons employed to work in the building
- coordination with any non-domestic occupier, such as commercial premises and community facilities
- arrangements for routine inspections of the building and its fire precautions, and, where appropriate, formal fire audits.

Step 6: Assess the likely consequences to people in the event of fire

This is based on an understanding of the fire protection measures and fire safety management. In addition, account needs to be taken of the way occupants are likely to

respond in the event of fire.

All that is normally required is a subjective judgement as to whether, as a result of shortcomings identified in Steps 4 or 5, there is an untoward exposure of people to injury or death in the event of a fire anywhere in the building, including a fire within a flat.

Step 7: Make an assessment of the fire risk

Fire risk is a combination of the likelihood of fire (identified in Step 2) and the consequences of fire (identified in Step 6). There is no unique way in which fire risk should be expressed, but it is innate to the process of carrying out the fire risk assessment that there be an assessment of fire risk, which it is then appropriate to document.

One simple method of consistently expressing fire risk is given in PAS 79 and can be useful for comparing the fire risk in one building to that in another (eg within the single estate of one organisation). This is reproduced below:

	Potential consequences of fire		
Likelihood of fire	Slight harm	Moderate harm	Extreme harm
Low	Trivial risk	Tolerable risk	Moderate risk
Medium	Tolerable risk	Moderate risk	Substantial risk
High	Moderate risk	Substantial risk	Intolerable risk

Step 8: Formulate and document an action plan

If it is considered that the fire risk and existing fire precautions are such that no improvements are necessary, this should be recorded within the fire risk assessment.

The action plan should address both physical fire precautions and managerial issues, and should normally prioritise measures (unless all required measures are relatively trivial and can be implemented in a short time), so that the appropriate effort and urgency is clear. Measures within the action plan should be both practicable to implement and possible to maintain, taking into account the nature of the building and its occupants.

Step 9: Set a date for review

The fire risk assessment should set a 'long stop' date by which it should be reviewed, even if no changes have taken place in the interim period.

Appendix 3

Selecting a competent professional fire risk assessor

A3.1 The FSO does not require that fire risk assessments are carried out by competent specialists. responsible persons, or their employees, can often carry out a fire risk assessment for a small, simple block of flats without formal training in fire safety or fire risk assessment, simply by studying relevant guidance. However, where external professional fire risk assessors are employed, it is important that they are competent, as criminal liability will arise for the responsible person if the fire risk assessment is not suitable and sufficient, and people are placed at risk of death or serious injury as a result.

A3.2 Competence does not necessarily arise from specific qualifications, but will be the result of a suitable blend of education, training and experience, knowledge and other qualities that enable a fire risk assessor to carry out a fire risk assessment for a block of flats.

A3.3 It is generally accepted that a competent fire risk assessor appointed by the responsible person for a block of flats will require an understanding of:

- the intent, objectives and requirements of the FSO, as it relates to a purpose-built block of flats
- the design principles of blocks of flats, including blocks constructed in accordance with previous standards and legislation
- the causes of fire and means for their prevention
- relevant fire protection measures, particularly means of escape and compartmentation in purpose-built blocks of flats
- the appropriateness of fire alarm systems in purpose-built blocks of flats
- the appropriateness of fire extinguishing appliances in purpose-built blocks of flats
- the appropriate evacuation strategies for purpose-built blocks of flats, including 'stay put' policies
- fire safety management, as it relates to purpose-built blocks of flats
- the effect of social and lifestyle factors on the risk to residents of purpose-built blocks of flats, and of the special needs for disabled people in the event of fire.

A3.4 At the time of publication of this guide, the Fire Risk Assessment Competency Council – a broad group of fire industry and business sector stakeholders – is preparing a

competency standard for persons who carry out fire risk assessments on a commercial basis. It is anticipated that this will be published by the end of 2011.

A3.5 Competence can often be established by professional registration or third-party certification. For example, a number of professional bodies operate registers of persons deemed to be competent to carry out fire risk assessments, and it is also possible to achieve certification of competence by an independent certification body. It is also possible for companies that carry out fire risk assessment work to achieve third-party certification by a certification body for this purpose. Use of registered or third-party certificated persons or third-party certificated firms to carry out fire risk assessments is one way responsible persons can establish due diligence in compliance with the requirement for a suitable and sufficient fire risk assessment.

A3.6 Purpose-built blocks of flats are very different in nature from commercial premises, such as offices, shops and factories. In selecting a fire risk assessor, the responsible person should ensure that the competence of the fire risk assessor extends specifically to the principles of fire safety applicable to purpose-built blocks of flats.

Appendix 4

Fire safety advice for residents

Fire Safety Advice:

Protecting you and your household

The easiest way to protect your home and family from fire is with a working smoke alarm

A smoke alarm can provide an early warning of a fire and allow you to make your escape – but only if it is working. You are more than twice as likely to die in a fire if you do not have a working smoke alarm.

- Fit smoke alarms on every level of your home.
- Test your smoke alarms regularly.
- Never disconnect or take the batteries out of your smoke alarm.

You can prevent fire from happening by taking a few simple steps

- Don't leave cooking unattended, and avoid leaving children in the kitchen alone with cooking on the hob.
- Be especially vigilant when cooking with oil. Don't overfill chip pans and NEVER throw water on a chip pan fire.
- Make sure cigarettes are put out properly, use a proper ashtray and don't smoke in bed.
- Don't overload electrical sockets.
- Turn off appliances when not in use. Don't even leave them on standby.
- Keep matches and lighters out of reach and sight of children.
- Make sure candles are secured in a proper holder and away from materials that may catch fire – like curtains. Children shouldn't be left alone with lit candles.

Keep safe and plan your escape

If your home is not already provided with smoke alarms, fit one in your entrance hallway (and landing of any upper or lower floor). For even better protection, fit one in your lounge and fit a heat alarm in your kitchen. Make sure your smoke and heat alarms meet British and

European standards. If you fit more than one, link them together so they all sound the alarm.

Get an electrician to fit mains-powered devices, and buy models that have a standby power supply in case of mains failure.

Your flat is in a building designed to be fire-resisting. A fire should not spread from one flat to another, so that you need not leave your home if there is a fire elsewhere in the block. That said, if in doubt, get out.

Always leave if your flat is affected by smoke or heat or if told to by the fire service.

Your stairway is designed to be safe for escape throughout the course of a fire. Always use the stairway to descend to ground level if escaping.

Do Not Leave Your Belongings Or Rubbish In Corridors, The Lift Lobby Or The Stairway.

This could affect you and your neighbours if there was a fire.

If you are in a corridor, lift lobby or stairway and you notice a fire, leave the building immediately and, if safe to do so, alert other residents in the immediate vicinity on your way out (knock on their doors).

Do Not Put Yourself At Risk. Do Not Return To Your Flat Until It Is Safe To Do So.

Remember:

- Test your smoke alarm once a week.
- Keep the exit route from your flat clear so you can escape in an emergency.
- Close doors at night, especially the doors to the lounge and kitchen to prevent fire spreading.
- Plan your escape NOW. Be prepared and don't wait until it happens.

Appendix 5

Examples of fire action notices

Example of notice for use in blocks with a 'stay put' policy

Fire Action

If Fire Breaks Out In Your Home:

- Leave the room where the fire is straight away, then close the door.
- Tell everyone in your home and get them to leave. Close the front door of your flat behind you.
- Do not stay behind to put the fire out.
- Call the fire service.
- Wait outside, away from the building.

If You See Or Hear Of A Fire In Another Part Of The Building:

- The building is designed to contain a fire in the flat where it starts. This means it will usually be safe for you to stay in your own flat if the fire is elsewhere.
- You must leave immediately if smoke or heat affects your home, or if you are told to by the fire service.
- If you are in any doubt, get out.

To Call The Fire Service:

- Dial 999 or 112.
- When the operator answers, give your telephone number and ask for FIRE.
- When the fire service reply give the address where the fire is.
- Do not end the call until the fire service has repeated the address correctly.

Example of notice for use in blocks with a communal fire alarm system and simultaneous evacuation

Fire Action

If Fire Breaks Out In Your Home:

- Leave the room where the fire is straight away, then close the door.
- Tell everyone in your home and get them to leave. Close the front door of your flat behind you.
- Do not stay behind to put the fire out.
- Raise the alarm by using a 'break glass' call point.
- Call the fire service.
- Wait outside, away from the building.

If You See Or Hear Of A Fire In Another Part Of The Building:

- The evacuation plan for this building requires all residents to proceed to the assembly point when the communal fire detection and alarm system sounds.
- You must also leave IMMEDIATELY if smoke or heat affects your home, or if you are told to do so by the fire service.
- If you are in any doubt, get out.

To Call The Fire Service:

- Dial 999 or 112.
- When the operator answers, give your telephone number and ask for FIRE.
- When the fire service reply give the address where the fire is.
- Do not end the call until the fire service has repeated the address correctly.

Appendix 6

Fire detection and fire alarm systems for blocks of flats

General comments

- A6.1 There has never been any requirement under Building Regulations, local acts or bye-laws to install a communal fire alarm system in a purpose-built block of flats, nor is there any such requirement today under the Building Regulations 2010.
- A6.2 Sometimes communal fire alarm systems have been, and are being, installed in blocks of flats. In some cases, where the means of escape and compartmentation can be demonstrated to be of a very poor standard, this may be warranted. However, fire alarm systems are often installed as a result of various misconceptions like unless the compartmentation can be proved to be adequate and uncompromised (which is rarely possible), communal fire alarm systems should be installed.
- A6.3 The real priority, in terms of fire warning, is to ensure that one or more working smoke alarms are provided in every flat. Indeed, it would be no exaggeration to say that, in current times, a flat without one or more working smoke alarms is not generally fit for occupation.

Smoke (and heat) alarms in dwellings

- A6.4 Smoke alarms would have been installed in each flat at the time of construction of any blocks of flats built after 1992. These smoke alarms are mains operated, but those installed prior to 2006 might not have a standby supply (battery or capacitor). Most of the models originally installed would have been of the ionisation chamber type. The typical lifetime of a smoke alarm is often considered to be around ten years, though smoke alarms may operate satisfactorily for several years longer than this.
- A6.5 It is essential that, in all flats, regardless of the date of construction, there is an adequate number of working smoke alarms (at least one per storey). In leasehold flats constructed before 1992, smoke alarms may be battery operated.
- A6.6 Smoke alarms in rented single-storey flats built before 1992 should only be battery operated if the battery has an anticipated life in normal service of at least five years, and if the battery is 'tamper proof' (ie removal necessitates the use of a tool). When any major electrical wiring takes place in rented flats, battery operated smoke alarms (and mains-operated smoke alarms without a standby supply) should be replaced with smoke alarms that are mains operated with a standby supply.

- A6.7 All smoke alarms in rented maisonettes should be mains operated with a standby supply. It is not recommended that battery-operated smoke alarms are installed in these maisonettes. Existing battery-operated devices should be replaced.
- A6.8 Generally, any new smoke alarms installed in the circulation spaces within flats should be of the optical type. These are less prone to false alarms from kitchens, and they respond better to slow smouldering fires.
- A6.9 At least one smoke alarm should be installed in the circulation space on each storey. For a higher standard of protection, consideration may be given to the installation of a smoke alarm in the lounge and a heat alarm in the kitchen. This higher standard of protection might be appropriate in flats occupied by vulnerable occupants or where the additional alarms are needed to compensate for shortcomings in the means of escape within the flat. In the latter case, battery-operated alarms should not be used.
- A6.10 For the highest standard of protection, a smoke alarm could be installed in all habitable rooms, other than kitchens, where heat alarms should be installed. This standard of protection is not normally justifiable, but might be appropriate in flats specifically designed, or provided, for those who are particularly vulnerable to fire, such as disabled people and those suffering from serious drug or alcohol abuse.
- A6.11 Where more than one alarm is installed these should be interlinked to maximise the audibility of the fire alarm signal. As well as models that are interlinked by wiring, radio-linked smoke alarms are available. It is preferable that all smoke alarms incorporate an alarm silence control, so that false alarms do not cause unnecessary or prolonged disruption to the residents of a flat.
- A6.12 Where occupants of a dwelling are deaf or hard of hearing and are likely to be alone at any time within a flat, suitable smoke alarm kits complying with BS 5446-3 should be used. These incorporate one or more flashing beacons, to alert people who are awake, and vibrating pads to wake people who are asleep. A vibrating pager can be incorporated in addition to these devices.
- A6.13 Although the above paragraphs refer to smoke alarms, a more sophisticated system, incorporating smoke detectors within an intruder alarm system, can be provided. Alternatively, a complete fire alarm system of the type found in commercial premises could be installed, but the cost of this is unlikely to be justifiable in most cases.
- A6.14 In sheltered housing, fire alarm signals from individual flats should be relayed to the same location as alarm signals from any social alarm system. If there is an on-site scheme manager, fire alarm signals should be investigated by the scheme manager – eg using a two-way speech communication facility between the scheme manager’s facility and the dwelling – prior to summoning of the fire and rescue service. If no on-site scheme manager is present, and fire alarm signals are transmitted to an alarm receiving centre that has a direct two-way speech facility for communication with the flat, the

alarm receiving centre should endeavour to determine, by using of this facility, whether the alarm signal is a false alarm, before the fire and rescue service is summoned.

- A6.15 Where fire alarm signals are transmitted to an alarm receiving centre by the same equipment as social alarm signals, the two types of signal should be separately identifiable at the alarm receiving centre. It should be ensured that the receipt of fire alarm signals cannot be delayed significantly by a previously initiated social alarm signal.
- A6.16 If smoke (and heat) detectors are connected to an existing social alarm system that has no facilities for discrimination between different types of alarm signal, the recommendation for distinguishable signals need not be followed in the case of signals transmitted to an on-site scheme manager. This is provided that the pre-planned response by the scheme manager to signals from the fire alarm system in any flat is identical to the pre-planned response to other alarm signals and is an appropriate action in the event of fire.
- A6.17 For guidance on the design, installation, commissioning and maintenance of fire alarm systems and smoke alarms in dwellings, reference should be made to BS 5839-6. Smoke alarms, heat alarms and fire alarm systems should only be installed by competent persons that are preferably third-party-certificated to carry out this work.

Communal fire detection and fire alarm systems

- A6.18 There is normally no need for a communal fire alarm system. However, it is common for smoke detectors to operate automatically opening vents, which keep the common parts, particularly stairways, free from smoke.
- A6.19 No fire alarm sounders should be connected to these detectors. Any existing sounders should normally be disconnected.
- A6.20 It is not only unnecessary to provide a communal fire alarm system, it is also normally undesirable. Before installing any form of communal fire alarm system, it will normally be necessary to get advice from fire safety specialists with substantial experience of advising on fire safety measures in blocks of flats.
- A6.21 However, there may be unusual circumstances, in which it might be necessary to consider the installation of a communal fire alarm system. Nevertheless, this does not imply that such a system need incorporate fire detectors within all flats, or that, in the event of detection of fire, an evacuation signal need be sounded. In particular, it will normally be wholly inappropriate to adopt simultaneous evacuation of all floors in a high-rise block.

A6.22 Where, in addition to smoke alarms within flats, it is considered necessary to install a communal fire alarm system in a block of flats. It is necessary to separately consider:

- the extent of the fire detection
- the extent to which sounders are provided
- the areas in which alarm signals should be given.

Account should be taken of the need to avoid false alarms and the risk of evacuating residents who would be safe to remain in their flats, into areas into which they might be affected by smoke.

A6.23 There are certain special circumstances in which a communal fire alarm system is always appropriate. The most common examples of these are certain forms of sheltered housing.

A6.24 In its simplest form, sheltered housing is, architecturally, and in terms of the facilities provided, no different from a 'general needs' block of flats. There may be no need for a communal fire alarm system in simple sheltered housing of this type.

A6.25 However, at the other extreme, many modern sheltered housing blocks incorporate communal facilities, such as communal lounges, guest rooms, hairdressers, laundries and sometimes even restaurants. The communal and commercial premises should be protected with a fire alarm system complying with the recommendations of BS 5839-1 for a Category L1 or L2 system. Fire detectors and fire alarm sounders should also be installed throughout the common parts, including corridors containing flats, and in all communal rooms and non-domestic premises off the common corridors. The system should also incorporate manual call points.

A6.26 The communal fire alarm system in these cases need not always extend into the individual flats, provided it is considered that, in the event of a fire anywhere within the building, residents are safe to remain within their own flats. In that case, the sound pressure level of the fire alarm system in the common parts should be low enough to avoid sound pressure levels of more than 45dB(A) within the flats.

A6.27 Where a communal fire alarm system is installed in sheltered housing, fire alarm signals should be monitored at a 24 hour staffed location, such as an alarm receiving centre. The smoke detectors within flats, provided to give residents a warning of a fire in their own flat, may be incorporated in the system, but, since, normally, in the event of a fire in a flat, a 'stay put' policy will apply to other flats, operation of a smoke detector within a flat should only operate the sounder within that flat.

A6.28 Another situation in which a communal fire alarm system might be appropriate is flats that form part of a mixed-user development. An example is flats located above shops. In these cases, unless there is adequate fire resistance between the shops and the flats immediately above, residents will be at risk from a fire within the shops.

A6.29 Often the safety of residents can best be achieved by upgrading the fire resistance between the shops and the flats. However, alternatively, heat detection can be installed within the shops and fire alarm sounders can be installed within the flats to evacuate the flats in the event of a fire in the shops. Under these circumstances, there is no need for the communal fire alarm system to incorporate fire detectors within the flats or the common parts of the flats.

A6.30 In blocks which do not have independent access to the flats, there may also be a need to extend the fire alarm system into the flats above. However, a system configuration which avoids having to evacuate all residents simultaneously is to be preferred, subject to all other aspects of compartmentation and means of escape being able to support a 'stay put' policy.

Appendix 7

Case study: Three-storey block, with flats opening directly onto a single stairway

- A7.1 As a result of a Type 1 fire risk assessment, the need to upgrade fire safety measures in this 1970s purpose-built block of flats was identified. The three-storey block has six self-contained flats. Each of the flats is accessed directly off a single stairway. The common parts comprise the entrance hallway, the stairway and the landings on each upper floor.
- A7.2 Constructed from concrete and brick, the block has rendered timber façades front and rear. Floors were found to be of concrete, and the building has a concrete stairway.
- A7.3 The block had been designed on the 'stay put' principle, and, consequently, there was no communal fire alarm system. As such, it met not only the original design standard, but also the current benchmark.
- A7.4 The block was found not to have a lobby between the flats and the stairway. This would still meet current benchmark standards, provided there was an internal protected entrance hall in each flat and an AOV at the top of the stairway, operated by smoke detectors on each landing.
- A7.5 Given that a sample of flats were accessed for this Type 1 fire risk assessment, primarily to check the standard and condition of flat entrance doors, it was soon established that the protection to the entrance halls was not in line with current standards. As a result of the age of the block, the stairway did not have an AOV, although smoke venting could easily be achieved by opening windows.
- A7.6 The front entrance doors to flats were also found to be original and not therefore in line with the current benchmark standard on these doors. Nevertheless, the original doors were fire-resisting and met the standard of the day. Part of that standard, however, permitted the use of rising butt hinges as was the case here.
- A7.7 The majority of the flat entrance doors were found to be in good condition, although it was noted that one had been fitted with a cat flap and another was badly fitting in its frame.
- A7.8 While most doors were the same, there were a number of doors that appeared to have been changed more recently. It transpired that some leaseholders had replaced the original doors, but with doors that were not fire-resisting.

A7.9 It was not considered reasonably practicable to bring the block into line with current benchmark standards. Account was taken of the good standard of compartmentation, including the lack of any common extract ventilation from flats.

A7.10 Overall, the fire risk assessment did not consider that the issues relating to the common parts posed a high risk to people. However, the action plan included a number of short-term and long-term solutions to address the findings. In summary, these were as follows.

Short-term solutions

- To require the leaseholders to replace front doors to their flats if they were not fire-resisting.
- To fit positive action self-closing devices in place of rising butt hinges to all original flat entrance doors.
- To repair the badly fitting door, or, if a repair was not possible, to replace it with an FD30S fire-resisting, self-closing door meeting current fire door standards.
- To remove the cat flap and repair the door to at least restore its integrity, to fit a 'replacement FD30S door'.

Long-term solutions

- As and when the opportunity arose, to upgrade or replace the front entrance doors to meet current benchmark standards and in particular, to fit intumescent strips and smoke seals and protected letter boxes. It was suggested to the landlord that this could be during the course of the normal maintenance programme or at time of major refurbishment.

Appendix 8

Case study: Five-storey block, with excess travel distance and other issues

- A8.1 This early 20th-century block of flats comprises a total of 30 flats, spread over a ground and four upper floors. Access to each upper floor flat is by means of a single stairway, leading to a common corridor on each floor. A single fire-resisting, self-closing door separates the common corridor on each floor from the stairway.
- A8.2 There are large, openable windows in every corridor and within the stairway that can be used to vent smoke.
- A8.3 The building is of substantial construction, with concrete floors and masonry walls, providing a good standard of fire resistance between flats, and between flats and the common parts. This provides support for the 'stay put' policy that has always been adopted and the absence of any communal fire alarm system.
- A8.4 A Type 3 fire risk assessment has been carried out. It was noted that the travel distance from the furthest flat entrance door to the stairway was 12m. Inspection of electrical risers within common parts revealed that not all cable penetrations between the risers and the flats were adequately fire stopped.
- A8.5 Within a sample of the flats inspected, it was found that there are quite short internal entrance halls, with substantial doors separating each room from the hallway. Bedrooms are located nearer to the flat entrance door than kitchens and lounges.
- A8.6 From inspection of a sample of flat entrance doors, it was determined that the original doors met the standard of the day for fire resistance, but some self-closing devices had been removed by residents.
- A8.7 It was found that the landlord had not provided smoke alarms. However, many residents had installed their own battery-operated smoke alarms. In some cases, batteries had been removed because of false alarms during cooking.
- A8.8 In the course of the fire risk assessment, it was noted that there are common extract facilities from both kitchens and bathrooms. The configuration of the extract arrangements needed further investigation. From this investigation, it was determined that the extract arrangements from each flat do not take the form of shunt ducts, but simply horizontal ducts that join the main duct. No fire dampers were present.

A8.9 Following on from the fire risk assessment, the action plan included a number of short, medium and long-term solutions to address the findings. In summary, these were as follows.

Short-term solutions

- To install battery-operated (Grade F) smoke alarms (with tamper proof lithium batteries) in the hallway of each flat. In one flat, in which the occupant was deemed to be vulnerable, an interlinked heat alarm was installed in the kitchen, and an interlinked smoke alarm installed in the lounge.
- To fire stop all cable penetrations between electrical risers and flats.
- To replace all missing self-closing devices.

Medium-term solutions

- In view of the extended travel distance, to upgrade all flat entrance doors to upgraded FD30S standard (along with those to the stairway).
- To fit intumescent fire dampers to kitchen and bathroom extract ducts.
- To provide either PVs or AOVs in the corridors and the stairway.

Long-term solutions

- To upgrade smoke alarms with Grade D, mains-operated smoke alarms, with a standby power supply.
- To reconfigure ventilation from the kitchens direct to outside and not via the common ducts.

Appendix 9

Case study: Nine-storey block, with inadequate smoke control and other issues

- A9.1 As a result of a Type 1, and subsequently a Type 2, fire risk assessment, the need to upgrade fire safety measures in this 1960s purpose-built general needs block of flats was identified.
- A9.2 The nine-storey, single-stairway block has a total of 51 self-contained 'general needs' flats. There are six flats on each of floors one to eight, which are accessed through a common lobby off the single stairway. The stairway has direct access to a final exit at the base of the stairs.
- A9.3 The block is of concrete framed construction, with concrete floors, internal block walls to the common parts and a concrete stairway. The block has a flat roof constructed of concrete, with an asphalt covering. As part of a refurbishment programme, the stairway, which was open originally on each of the upper floor levels, was enclosed with glazed partitions and openable windows. The block had been designed on the 'stay put' principle, and, consequently, there was no communal fire alarm system.
- A9.4 Access to the flats is via a common lobby providing two door protection to the single stairway, which is consistent with current benchmark standards. The travel distance within the lobbies to the door to the stairway is approximately 6m, which is in excess of the current recommended benchmark of 4.5m. The smoke control arrangements in the lobbies, which are not provided with any means of ventilation, and within the stairway, which only has openable windows, are not in accordance with current benchmark guidance, which would require AOV's in the lobbies and the stairway.
- A9.5 In addition, the refuse chutes, which, in the original design, were located off an open balcony within the stairway on each of the upper floors, are now within an enclosed stairway and present a risk of fire and smoke spread.
- A9.6 The flat entrance doors were also found to be original and not, therefore, in line with the current benchmark standards. Nevertheless, the original doors were fire-resisting and met the standard of the day. Part of that standard, however, permitted the use of rising butt hinges as was the case here.
- A9.7 The majority of the flat entrance doors were found to be in good condition, although it was noted that the original fire-resisting glazing over two of the doors had been

replaced, one with hardboard and the other with plain glazing. While most doors were the same, a number of doors had been changed as part of the refurbishment programme. Two of the leaseholders had replaced the original doors, with new uPVC doors that were not fire-resisting.

A9.8 The survey identified a reasonable standard of compartmentation in the common areas, with only minor openings in floors around cables within the common service riser cupboards. In addition, the false ceilings in the common parts were opened and accessed to check openings between the flats, store rooms and the electrical intake room and the common areas. Again, only minor openings around cables and pipes were found. All of these openings would be relatively easy to fire stop with suitable materials.

A9.9 Compartmentation within the flats was also considered, and had been checked during the refurbishment programme, which did not identify any significant defects. The kitchens were provided with separate extract vents direct to open air, and the service risers containing electric, water and waste pipes were enclosed in a common duct in what appeared to be solid construction providing a reasonable period of fire resistance. The bathrooms were provided with a common vent and duct that served all bathrooms, with mechanical extract ventilation with a fan at roof level. Further investigation by a contractor revealed that there were no fire dampers in bathroom extract facilities, and that shunt ducts were not incorporated.

A9.10 The fire risk assessment identified a number of significant deficiencies within the common parts. Some of these were as a result of changes made to the block. While it was not considered reasonably practicable to bring the block fully into line with current benchmark standards for single stairway buildings, the action plan included a number of short, medium and long-term solutions to address the findings. In summary, these were as follows.

Short-term solutions

- To require the two leaseholders to replace the front doors to their flats with replacement FD30S doors, with positive action self-closing devices.
- To fit positive action self-closing devices in place of rising butt hinges to all flat entrance doors.
- To replace, the non-fire-resisting glazing over the flat entrance doors, with fire-resisting glazing.
- As a temporary measure, permanently open one of the windows on each landing within the stairway to provide permanent ventilation, or alternatively close off the refuse chutes to prevent their use by residents.
- Provide fire stopping to any openings around pipes and cables in fire-resisting floors and walls.

Medium-term solutions

- Enclose the refuse chutes on each floor with partitions and self-closing doors providing 30-minute fire resistance, and provide permanent ventilation to the enclosure, or, alternatively, permanently seal off the refuse chutes on each floor level.
- To fit intumescent dampers to the vent openings within each of the bathrooms to prevent the spread of fire between flats.

Long-term solutions

- To upgrade all flat entrance doors and doors to the store rooms, cleaner's cupboard, electrical intake room and the stairway to FD30S doors.
- The doors to the riser cupboards on each floor were notional FD30 doors and, provided the storage is removed, there would be no requirement to upgrade these doors. However, the doors should be kept locked shut and be provided with suitable notices.
- As the travel distance within the lobbies is limited, and there is no practical way of providing ventilation, unventilated lobbies were accepted. However, to compensate for this and upgrade the smoke control in the stairway, AOVs or PVs were required in the stairways. If AOVs were installed, smoke detectors would need to be fitted in both the lobbies and the stairway.

Appendix 10

Case study: Mixed-use block with inadequate compartmentation

- A10.1 During refurbishment works to this pre-20th-century building, significant weaknesses in the structural fire protection were identified. This cast doubt on the effectiveness of the compartmentation normally needed for this mixed-use residential block.
- A10.2 The four-storey building had three self-contained flats, one on each of the upper floors. The ground and basement floors were occupied by two shops.
- A10.3 Each of the flats was accessed directly off a single staircase. The common parts comprised the entrance hall, the staircase and the landings on each upper floor. Although the two shop units on the ground floor had independent entrances from the street, one also had a door into the entrance hall.
- A10.4 Built with brick walls, the block had timber floors and the staircase was of timber construction. The original roof had been replaced with a metal-clad roof.
- A10.5 The block had been designed on the 'stay put' principle, and, consequently, there was no communal fire alarm system. As such, it met not only the original standard on this but also the current benchmark.
- A10.6 The block was found not to have a lobby between the flats and the stairway. Although all had entrance hallways, none of these were protected. There was no automatic vent in the stairway for smoke ventilation and none of the flat entrance doors were considered even notional FD30 doors.
- A10.7 The first and second floor levels had access to alternative exits onto external metal fire escape stairways. However, these could not be reached from all rooms. The top floor flat had no access to the external escape stairway, although a ladder gave access to the roof for residents to await rescue, which is not acceptable today.
- A10.8 The works to the building revealed serious deficiencies in both the standard of the fire separation and its condition. Ceilings were lined with lath and plaster and, in some parts, a composite of plywood, chipboard and hardboard. Some walls, including those enclosing the staircase, were of thin timber panels and it was possible to see between a flat and the stairway through splits in the panels.

- A10.9 Given the situation found, it was considered that the residents were exposed to an unacceptable risk. However, it was not considered reasonably practicable to bring the block into line with current benchmark standards. While every effort was made to improve the condition of fire separation, including fitting replacement FD30S flat entrance doors, it was not realistic to fully upgrade floors and walls.
- A10.10 Despite misgivings over the implications for false alarms, it was decided that a fire detection and fire alarm system would need to be installed. The alternative of fitting a sprinkler system was considered as an option, but there was no room to house the necessary tank and pumps. The communal system provided, a Category L1 system to BS 5839-1, extended into the flats. This was not only to ensure all residents were warned of an activation of the system, but also to provide fire detection in all habitable rooms. Manual call points were also fitted by the ground floor exits, but not on the upper-floor landings.
- A10.11 Given that the detectors were installed in flats to compensate for serious shortcomings in fire separation, heat detectors were used. These were deemed sufficient to provide warning before fire-spread between flats and also to reduce the potential for false alarms from residents. However, in recognition that these would not provide local warning for the occupants of each flat, smoke alarms were also installed in each of the flats.

Appendix 11

Case study: Block containing two-storey flats, without adequate alternative exits

- A11.1 As a result of a Type 3 fire risk assessment, the need to upgrade fire safety measures within the individual flats of a 1960s purpose-built block was identified.
- A11.2 This is a four-storey, purpose-built block of flats, with a total of eight, two-storey, self-contained general needs flats. Four of the flats are entered directly off the single stairway on the ground floor level, with the remaining four flats entered off the single stairway on the second floor level.
- A11.3 The block itself is of concrete framed construction, with concrete floors, internal block walls to the common parts and a concrete stairway. The block originally had a concrete flat roof, but a new timber and tiled pitched roof was installed over the existing flat roof a number of years ago.
- A11.4 The flats open directly off the single stairway and originally had internal protected entrance halls providing two-door protection to the stairway, which was in accordance with the benchmark standard of the day. The risk assessment for the common parts was considered separately and is not included within this case study, which only considers the fire safety measures necessary to protect the residents from a fire within their own flat.
- A11.5 The flats themselves are arranged on two levels. On the entry level, there is a small hallway with doors to the kitchen, living room and toilet. An internal stairway provides access to the upper level, on which there are three bedrooms and a bathroom.
- A11.6 The original means of escape arrangements incorporated an alternative fire exit on the landing, adjacent to the bedrooms, on the upper level of each flat. On the first floor, the exit led directly into the stairway and, on the third floor, the exit led onto the roof and then back into the stairway. In addition, the doors to the kitchen and lounge were fire-resisting doors fitted with rising butt hinges. The doors to the bedrooms on the upper levels were not fire-resisting.
- A11.7 The alternative fire exits from the first floor level of the block remain available, although a number of the doors were obstructed and, in one case, permanently locked shut. The alternative fire exits from the fourth-floor level of the block have been removed following the installation of the pitched roof. In addition, in general, kitchen and living-room doors

have been removed or replaced with non-fire-resisting doors in a number of flats. The glazing fitted at high level between the hall and living rooms is not fire-resisting.

A11.8 The flats are fitted with interlinked Grade F smoke alarms, located in the hall and on the upper-level landings.

A11.9 It was not considered reasonable or physically possible to either re-instate the original means of escape arrangements, particularly on the third floor, or bring the flats fully into line with current benchmark fire safety standards.

A11.10 The fire risk assessment identified a significant problem with the internal means of escape from the upper levels of the flats, particularly at third-floor level, as a result of changes made to the block, and other less significant issues that could be dealt with over a longer period of time. The action plan, therefore, included a number of short and medium-term solutions to address the findings. In summary, these were as follows.

Short-term solutions

- To upgrade the fire detection and alarm system in all flats, with, in the first instance, particular emphasis on the upper-level flats, to compensate for the removal of the alternative exits on the fourth floor. A Grade D, Category LD2 system was recommended, with smoke alarms fitted in the hall, living room and upper-level landings and a heat alarm fitted in the kitchens.
- To replace any doors removed from the kitchens or living rooms with FD20 doors.
- To inspect existing doors fitted to kitchens and living rooms and ensure that they are a good fit in their frames and provide a reasonable level of fire resistance.
- To ensure alternative fire exits on the upper landing at first floor level are opened up and made available and can be easily opened by the residents.
- To provide residents with general fire safety information and emphasise the need to keep kitchen and living-room doors closed, particularly at night.

Medium-term solutions

- To replace the glazing between the hall and living rooms with fire-resisting glazing.
- In the upper-level flats, to consider the fitting of self-closing devices to kitchens and living-room doors.

Appendix 12

Case study: Block containing single-storey flats, without adequate alternative exits

A12.1 As a result of a Type 3 fire risk assessment, the need to upgrade fire safety measures within the individual flats of a 1930s purpose-built block was identified.

A12.2 This is a six-storey, purpose-built-block of flats, with a total of 24 self-contained, two- and three-bedroom general needs flats, accessed off a common single stairway. There were four flats on each floor entered directly from the single stairway. All the flats were occupied by long-term tenants of a single landlord, who owned a number of similar properties in the area.

A12.3 The block itself is of traditional construction, with brick exterior walls, timber floors, internal brick and block walls between the flats and the concrete stairway, and a tiled timber-pitched roof. The timber floors were in-filled with hollow blocks at the time of construction to provide fire separation between the floors which was common for buildings of this age.

A12.4 The flats open directly onto the single stairway and have internal protected entrance halls providing two-door protection to the stairway, which was common in buildings of the age and size. The stairway was open at ground floor level and had openable windows on the landings on the upper floors. The risk assessment for the common parts was considered separately and is not included within this case study, which only considers the fire safety measures necessary to protect the residents from a fire within their own flats.

A12.5 The flats themselves are arranged on one level and are accessed directly off the single stairway. There was a small entrance hall with doors to the kitchen and the living room. From the rear of the living room, a further door gave access to an inner hall with access to the bedrooms and bathroom.

A12.6 The flats were fitted with a Grade D Category LD3 fire detection and alarm system, with smoke alarms in the entrance hall and inner hall.

A12.7 Originally, the doors to the kitchen and living room off the entrance hall were fire-resisting doors fitted with rising butt hinges, as was the door between the living room and the inner hall, which was provided to separate the bedrooms from the living areas. As the bedrooms were inner rooms off the living room, an alternative means of escape was provided from one of the bedrooms onto an external shared balcony, which originally gave access to the adjoining flat through a kick-out panel between the two sections of the balcony. Residents were then required to gain access into and through their neighbours flat and back out onto the common single stairway.

A12.8 Over the years, as a result of security concerns, the majority of the panels between the balconies had been sealed up, and access no longer exists between the flats. In addition, even where the panel has been retained, access into the adjoining flat and out of the flat into the stairway would be difficult to achieve due to additional security measures fitted by residents to balcony and flat entrance doors and could not be relied on with any degree of certainty. The result of these changes has created an unsatisfactory means of escape arrangement for residents in the bedrooms. Without the original alternative means of escape, anyone in the bedrooms would have to pass through the living room to reach the flat entrance door. Should a fire occur in the living room, there is a significant risk that the occupants of the bedroom would become trapped and be unable to escape.

A12.9 In addition, in a number of the flats, the door to the kitchen had been removed or replaced with a non-fire-resisting door, and some of the doors were also found to be wedged in the open position. This was mainly due to the limited space within the kitchen and was common practice. This was an additional concern, which potentially increased the risk for the occupants of the bedrooms, who would need to use the entrance hall and pass the kitchen to leave the flat.

A12.10 It was not considered practicable or appropriate to re-instate the original means of escape arrangements, via the external balcony.

A12.11 The fire risk assessment identified a significant problem with the internal means of escape from the bedrooms and the removal of fire-resisting doors. The action plan therefore included a number of short- and medium-term solutions to address the findings. In summary, these were as follows.

Short-term solutions

- To ensure that all kitchens off the entrance hall are fitted with either the original fire-resisting door or replacement FD20 doors.
- To ensure that the door between the living room and the inner hall is at least a FD20 fire-resisting door.
- To provide residents with general fire safety information and emphasise the need to keep kitchen and living-room doors closed, particularly at night.
- To upgrade the existing fire detection and alarm system to a Grade D Category LD1 system, with smoke alarms in the entrance hall, living room, inner hall and bedrooms, and a heat alarm in the kitchen.

Medium to long-term solutions

- To fit an automatic suppression system to cover the living room, kitchen and entrance hall.
- To upgrade all remaining doors to FD20 standard.

Appendix 13

Case study: Three-storey leasehold block with uncooperative leaseholders

A13.1 The block is run by a residents' management company (RMC) which has appointed a managing agent, who arranges for a fire risk assessment to be carried out. The block was built in the 1990s of traditional build. It has three floors with a single staircase and four flats on each floor. The stairway leads to a final exit at the base of the stairs.

A13.2 A Type 1 fire risk assessment was carried out. The property manager from the agent accompanied the assessor and after knocking on a lot of doors was able check on one flat entrance door. This was found to be in good condition fitted with combined smoke seals and door closer. But it was noted that some other leaseholders had replaced their front doors with new UPVC doors that appeared not to be fire-resisting.

A13.3 The fire risk assessment found a reasonable standard of compartmentation in common areas. Suspended ceilings in common parts and above corridor fire doors were lifted. Only minor openings around pipes and cables were found. The service cupboards were checked and one was found not be locked. A pre-payment meter had been installed in a meter cupboard by the utility company without the consent of the RMC. A pram and bicycle were being stored on the ground floor lobby. No fire instruction notices were displayed. The agent, having recently been appointed on a 12-month contract, was not aware of:

- the standard of compartmentation inside flats
- whether smoke alarms had been installed
- when the leaseholders were last given any fire safety information.

A13.4 Following the risk assessment the agent presented the findings to the directors of the RMC and they agreed:

- to provide a good standard of fire stopping to any openings around cables and pipes in common areas above fire doors and within service riser cupboards
- a zero tolerance policy
- that the agent would contact the lessee who owned the pram and bicycle and ask that they be removed from the common parts as an obstruction
- that the agent would contact the utility company and the sub-tenant with the pre-

payment meter and ask for it to be moved into the flat

- that the agent would write to the relevant lessees with UPVC doors to point out that the lessees should change them – the agent had checked the leases and found that the lessees were responsible for the repair and replacement of the flat entrance doors
- fire instruction notices would be provided and clearly displayed on each floor
- that the agent would contact the community fire service and write to all lessees to encourage the installation of domestic smoke alarms in all flats
- that the agent would send appropriate fire safety information to all residents explaining the 'stay put' fire policy in use together with the need for good housekeeping and security both within the common areas and the flats.

A13.5 The agent wrote to the two lessees about their front doors. No replies were received. The agent followed up this letter with a further letter and then a visit to the lessees' flats. The agent discovered one of the lessees had sublet the flat and was abroad at the time. The sub-tenant in the flat would not deal with the issue of the door. The agent wrote again to the addresses he had for the lessees to state that unless the lessees took action then he would ask the directors to refer the matter to the relevant enforcing authority. After not getting any responses the agent sought advice about whether to contact the fire service or the local environmental health authority. With RMC's directors' approval the agent invited the environmental health authority to inspect the doors as a matter covered by the Housing Act 2004, with a view to enforcement action.

Glossary

This glossary sets out definitions to assist readers in understanding some of the technical terms used in this guide. In some cases, the definitions relate specifically to this guide and may therefore differ to some degree from more generically applicable definitions. The definitions are not exhaustive. More precise definitions may be available in other guidance.

Access room	A room through which the only escape route from an inner room passes.
Alternative escape routes	Escape routes sufficiently separated by either direction and space, or by fire-resisting construction, to ensure that one is still available, irrespective of the location of a fire.
AOV (automatically opening vent)	A vent provided for smoke control in common parts, which opens automatically when smoke is detected by smoke detectors.
Approved Document B	Guidance issued by the government in support of the fire safety aspects of the Building Regulations.
Cavity barrier	A construction provided to close a concealed space against penetration of smoke or flame, or provided to restrict the movement of smoke or flame within such a space.
Cluster flat	A flat in multiple occupation, typically occupied by a particular group of people, such as students or key workers.
Combustible material	Material that can be burned.
Common balcony	A walkway, open to the air on one or more sides, forming part of the escape route from more than one flat.
Common parts	Those parts of a block of flats used by occupants of more than one flat for access and egress.
Competent person	A person with enough training and experience or knowledge and other qualities to enable them to properly assist in undertaking the fire safety measures recommended in this guide.
Compartmentation	Sub-division of a building by fire-resisting walls or floors for the purpose of limiting fire-spread within the building.
Compartment wall or floor	A fire-resisting wall or floor that separates one fire compartment from another.
Corridor access	A design of a block of flats in which each flat is approached via a common horizontal access or circulation space, which may include a common entrance hall.
Dead end	Area from which escape is possible in one direction only.

Destructive fire risk assessment	A fire risk assessment in which, by means of destructive exposure, access is obtained to view concealed construction.
Emergency escape lighting	Lighting that provides illumination for the safety of people leaving the building when the normal lighting fails.
Escape route	Route forming part of the means of escape from any point in a building to the final exit.
Evacuation lift	A lift that may be used for the evacuation of people with disabilities, or others, in a fire.
Final exit	An exit from a building from which people can disperse in safety, and beyond which they are no longer at danger from fire or smoke.
Fire compartment	A part of a building constructed to prevent the spread of fire to or from another part of the building.
Fire damper	Mechanical or intumescent device within a duct or ventilation opening, which is operated automatically in the event of fire, to prevent the passage of fire. (Where there is a need to prevent the passage of smoke, the fire damper needs to satisfy additional criteria.)
Fire-fighting lift	A lift, designed to have additional protection, with controls that enable it to be used under the direct control of the fire and rescue service when fighting a fire.
Fire-fighting shaft	A fire-resisting enclosure containing a fire-fighting stair, fire mains, fire-fighting lobbies and, if provided, a fire-fighting lift.
Fire load	Quantity of heat that could be released by the complete combustion of all the combustible materials in a space.
Fire main	Water supply pipe installed in a block of flats for fire-fighting purposes, fitted with landing valves at specific points. The main may be 'dry', in which case it is fitted with inlet connections at fire and rescue service access level, so that it can be charged with water from pumping appliances. In tall blocks, the main is 'wet' and is permanently charged with water from a pressurised supply.
Fire resistance	The ability of a component or construction of a building to satisfy, for a stated period of time, some or all of the appropriate criteria of relevant fire test standards.
Fire stopping	A seal provided to close an imperfection of fit or design tolerance between elements or components, to restrict the passage of fire and smoke.
Fire-resisting door	A door, together with its frame and furniture, provided for the passage of people, which, when closed, is intended to restrict the passage of fire and smoke to a predictable level of performance.

Fire-resisting door – Notional FD30 door	A door assembly that satisfied the current specification, or fire resistance test, for 30 minutes at the time of construction of a block of flats or manufacture of the door.
Fire-resisting door – Replacement FD30S door	A door assembly that has been independently certificated by a UKAS-accredited fire test laboratory as satisfying the relevant test requirements for 30 minutes integrity and control of the passage of smoke at ambient temperature.
Fire-resisting door – Upgraded FD30S door	A 'notional FD30' door, fitted with intumescent strips and smoke seals, and with any other necessary work carried out, such that it may reasonably be anticipated that it would satisfy the relevant test requirements for 30 minutes integrity and control of the passage of smoke at ambient temperature.
General needs block	A block of flats intended for occupation by members of the general public and not those of a specific demographic or vulnerability.
Habitable room	A room within a flat, used, or intended to be used, for dwelling purposes (including a kitchen, but not a toilet or bathroom).
Inner room	A room from which escape is possible only by passing through another room (the access room).
Material alteration	An alteration to the building that significantly affects (usually lowering or with the potential to lower) the level of risk to people from fire.
Means of escape	A route(s) provided to ensure safe egress from the premises or other locations to a place of total safety.
Non-destructive fire risk assessment	A fire risk assessment that does not involve destructive exposure (but normally will still involve opening a sample of accessible service riser doors and, for example, sample inspections where feasible above accessible demountable ceilings and so forth without use of tools).
OV (Openable vent)	A vent provided for smoke control in the common parts, which is opened by the fire and rescue service by means of hardware or a control (which may be located remotely) provided for the purpose.
Protected corridor or lobby	A corridor or lobby that is adequately protected from fire in adjoining accommodation by fire-resisting construction.
Protected entrance hall or landing	A circulation area consisting of a hall or space in a flat, enclosed in fire-resisting construction (other than any part that is an external wall of the building).
Protected route	An escape route that is adequately protected from the rest of the building by fire-resisting construction.

Protected stairway	A stairway that is adequately protected from the rest of the building by fire-resisting construction.
PV (Permanent vent)	A permanently open vent provided for smoke control in the common parts.
Reasonably practicable measures	Measures that reduce fire risk to an extent where the cost and effort to reduce the risk further would be grossly disproportionate to the remaining risk.
Relevant person	Any person lawfully on the premises and any person in the immediate vicinity (but not fire-fighters carrying out operational duties).
Self-closing device	Device that is capable of closing a door from any angle and against any latch fitted to the door.
Sheltered housing	A block of flats in which each flat is designed and constructed for the purpose of providing residential accommodation for vulnerable or elderly people, who receive, or are to receive, a support service.
Simultaneous evacuation	Procedure in which all parts of a block of flats are evacuated following the giving of a common alarm of fire.
Smoke alarm	Device containing within one housing all the components, except possibly the energy source, for detecting smoke and giving an audible alarm.
Smoke containment	A method of smoke control involving physical barriers to the spread of smoke, usually in combination with vents, primarily to prevent the passage of smoke into escape stairways.
Smoke dispersal	A method of smoke control frequently used in older blocks of flats at the time of their construction (but now deprecated). Vents were sited in such a way as to achieve uninterrupted natural cross-ventilation of corridors and lobbies in an endeavour to dilute and disperse any smoke in these areas.
‘Stay put’	An evacuation strategy based on the principle that only the residents of the flat of fire origin need to escape initially, while other residents may remain in their own flats.
Travel distance (within a specified area, such as a flat, the hallway of a flat or a common corridor)	The actual distance to be travelled by a person from any point within the specified area, to the nearest exit leading to a place of relative safety in which the person is in no immediate danger from fire.
Unventilated corridor or lobby	Corridor or lobby with no vents or other means of smoke control.
Ventilated corridor or lobby	Corridor or lobby with means of smoke control.

Bibliography

Legislation

'The Regulatory Reform' (Fire Safety) Order 2005

<http://www.legislation.gov.uk/uksi/2005/1541/contents/made>

'Building Regulations 2000' (superseded)

<http://www.legislation.gov.uk/uksi/2000/2531/contents/made>

'Building Regulations 2010'

<http://www.legislation.gov.uk/uksi/2010/2214/contents/made>

'Building Act 1984'

<http://www.legislation.gov.uk/ukpga/1984/55>

'Housing Act 2004'

<http://www.legislation.gov.uk/ukpga/2004/34/contents>

'The Construction' (Design and Management) Regulations 2007

<http://www.legislation.gov.uk/uksi/2007/320/contents/made>

Guidance on legislation

HM Government Guide 'Fire safety risk assessment: sleeping accommodation', Department for Communities and Local Government (DCLG), May 2006.

<http://www.communities.gov.uk/documents/fire/pdf/151339.pdf>

'Approved document B: Fire safety' (Volume 2), Department for Communities and Local Government (DCLG), April 2007.

<http://www.canterbury.gov.uk/assets/buildingcontrol/approved-document-b-vol2-2006a.pdf>

'Housing health and safety rating system – guidance for landlords and property related professionals', Department for Communities and Local Government (DCLG), May 2006.

<http://www.communities.gov.uk/documents/housing/pdf/150940.pdf>

'Housing – fire safety: guidance on fire safety provisions for certain types of existing housing', Local Authorities Coordinators of Regulatory Services (LACoRS), (now known as Local Government Regulation), in partnership with the Chief Fire Officers' Association and the Chartered Institute of Environmental Health, July 2008.

<http://www.lacors.gov.uk/lacors/NewsArticleDetails.aspx?id=19844>

<http://www.landlordzone.co.uk/pdf/FireSafety.pdf>

'Protocol between Local Housing Authorities and Fire and Rescue Authorities to improve fire safety', October 2010.

<http://www.lacors.gov.uk/lacors/upload/25462.pdf>

'Protocol between Local Housing Authorities and Fire and Rescue Authorities to improve fire safety', 2007.

<http://www.lacors.gov.uk/lacors/upload/25463.pdf>

Other guidance

'Electrical Safety in Communal Areas of Residential Properties'. The Electrical Safety Council, 2011.

http://www.esc.org.uk/uploads/tx_escvideolib/filedownload/Communal_Areas_ESC_online-version_02.pdf

'Fire safety in construction – Guidance for clients, designers and those managing and carrying out construction work involving significant fire risks'. Health and Safety Executive, 2nd edition, 2010.

<http://www.hse.gov.uk/pubns/priced/hsg168.pdf>

British Standards

British Standard code of practice 'CP3 chapter IV: precautions against fire', 1948, (superseded)

British Standard code of practice 'CP3 chapter IV part 1: precautions against fire', 1962, (superseded)

British Standard code of practice 'CP3 chapter IV part 1: precautions against fire', 1971, (superseded)

BS 5266-1: 2005, 'Code of practice for the emergency lighting of premises'

BS 5266-7: 1999, 'Lighting applications – emergency lighting'

BS 5266-8: 2004, 'Emergency escape lighting systems'

BS EN 1634-1: 2008, 'Fire resistance and smoke control tests for door, shutter and openable window assemblies and elements of building hardware, Fire resistance tests for doors, shutters and openable windows'

BS EN 1634-2: 2008, 'Fire resistance and smoke control tests for door, shutter and openable window assemblies and elements of building hardware, Fire resistance characterisation test for elements of building hardware'

BS EN 1634-3: 2004, 'Fire resistance and smoke control tests for door, shutter and openable window assemblies and elements of building hardware, smoke control test for door and shutter assemblies'

BS EN 12485: 2004, 'Fixed fire-fighting systems – automatic sprinkler systems – design, installation and maintenance'

BS EN 62305-2: 2006, 'Protection against lightning, risk management'

BS EN 62305-3: 2006, 'Protection against lightning, physical damage to structures and life hazard'

BS 476-22: 1987, 'Fire tests on building materials and structures, methods for determination of the fire resistance of non-load-bearing elements of construction'

BS 5306-3: 2009, 'Fire extinguishing installations and equipment on premises, commissioning and maintenance of portable fire extinguishers, code of practice'

BS 5446-3: 2005, 'Fire detection and fire alarm devices for dwellings, specification for smoke alarm kits for deaf and hard of hearing people'

BS 5588-1: 1990, 'Fire precautions in the design, construction and use of buildings. Code of practice for residential buildings' (in the course of revision)

BS 5839-1: 2002, 'Fire detection and fire alarm systems for buildings, code of practice for system design, installation, commissioning and maintenance'

BS 5839-6: 2004, 'Fire detection and fire alarm systems for buildings, code of practice for the design, installation and maintenance of fire detection and fire alarm systems in dwellings'

BS 7273-4: 2007 'Code of practice for the operation of fire protection measures, actuation of release mechanisms for doors'

BS 9251: 2005, 'Sprinkler systems for residential and domestic occupancies, code of practice'

BS 9990: 2006, 'Code of practice for non-automatic fire-fighting systems in buildings'

BS 9999: 2008, 'Code of practice for fire safety in the design, management and use of buildings'

DD 8489-1: 2011, 'Fixed fire protection systems, Industrial and commercial watermist systems, code of practice for design and installation'

DD 8485-1: 2010, 'Fixed fire protection systems, residential and domestic water mist systems, code of practice for design and installation'

British Standards Institution publication

PAS 79: 2007, 'Fire risk assessment – Guidance and a recommended methodology, BSI, 2007.'

Other guidance

'Electrical Safety in Communal Areas of Residential Properties', the Electrical Safety Council, 2011.

'Fire safety in construction – guidance for clients, designers and those managing and carrying out construction work involving significant fire risks', Health and Safety Executive, second edition, 2010.

'Fire prevention on construction sites – the joint code of practice on the protection from fire of construction sites and buildings undergoing renovation' (seventh edition), Fire Protection Association Publications, 2009.

'Code of practice: Refurbishment of communal buildings and the fire risk of multi-layer paints', Warringtonfire, 2005

The Institution of Engineering and Technology (IET) publications

'Code of practice for the in-service inspection and testing of electrical equipment', third edition, IET, 2008.

'Requirements for electrical installations: IEE wiring regulations', 17th edition (BS 7671: 2008). IET, 2008

'IET Guidance Note 3: Inspection and Testing', 5th edition, IET, 2008

Index

A

- Access for fire-fighters 23, 54, 90, 91, 106, 110, 116, 120, 121, 132
- Alarms (see fire alarm systems)
- Alterations 18, 34, 35, 49, 94, 112, 114, 121, 129-130, 131, Appendix 1
- Anti-social behaviour 53, 55, 59, 61, 127
- AOVs (automatically opening vents) 86, 89, 95, 96, 97, 115, 123, Appendices 7, 9
- Approved products and services (see third-party certification)
- Arson 51, 53, 59, 127, Appendix 2
- Assembly point 118, Appendix 2
- Automatic fire detection systems (see also fire alarm systems) 72, 76, 83, 94, 95, 96
- Automatic fire suppression systems (see fire suppression systems) 22, 76, 81, 83, 94, Appendix 12

B

- Building Regulations 12, 14, 25, 32, 34, 35-36, 38, 43, 70, 79, 129, Appendices 1, 2, 6

C

- Car parks 26, 85, 89
- Cavity barriers 87, 111, 130
- Cladding (see external cladding)
- Compartmentation 22, 28, 29, 30, 31, 45, 66, 71-75, 104, 106, 126, Appendices 1, 2, 3, 6, 7, 9, 10, 13
- Competence 41, 48, 118, Appendix 3
- Competent person 50, 63, 114, 122, Appendices 2, 3, 6
- Construction, fire-resisting 20, 23, 25, 78, 85, 103, 106, Appendix 2
- Contractors 30, 34, 38, 45, 46, 50, 53, 63, 64, 65, 121, 122, 124, 125, 127, 129, Appendices 2, 9

D

Dead ends 25, 32, 60, 86, 100, Appendix 1

Destructive fire risk assessment 41, 43, 46, 50, 73

Disability (see people with special needs)

Disabled 21, 26, 47, 59, 76, 109, 120, 132, Appendices 1, 2, 3, 6

Doors

signs 101

flat entrance 24, 25, 26, 35, 37, 39-40, 43, 45, 52, 55, 66, 70, 76, 77, 78, 79, 80, 82, 87, 89, 91, 96, 100, 101, 103, 105, 106, 109, 110, 128, 130, Appendices 1, 7, 8, 9, 10, 12, 13

fire-resisting 25, 35, 40, 43, 46, 54, 70, 72, 77, 78, 79, 84, 89, 91, 92, 94, 96-100, 101, 109, 112, 125-126, Appendices 1, 8, 10, 11, 12, 13

maintenance 36, 37, 39, 40

self-closing devices 25, 35, 40, 43, 54, 66, 70, 79, 84, 89, 91, 98, 99, 100, 102, 105, 106, 108, 109, 125, 128, 130, Appendices 1, 8, 13

Dry riser (see fire mains)

Dry rising mains (see fire mains)

E

Electrical hazards 62-64

Electrical safety 116

Emergency lighting (*see emergency escape lighting*)

Emergency escape lighting 30, 38, 67, 102

tests, checks and maintenance 122-123

Emergency plans 38, 44, 118, Appendix 2

Escape lighting (*see emergency escape lighting*)

Escape routes

alternative exits 20, 22, 23-26, 66, 76, 77, 80-81, 82, 101, 105, 108, Appendices 11, 12

capacity 85

corridors 23, 24, 25, 60, 61, 76, 80, 84, 85, 86, 87, 89, 90, 91, 95, 96, 97, 99, 100, 102, 103, 106, 109, Appendix 1

dead ends 25, 32, 60, 86, 100, Appendix 1

emergency lighting (*see emergency escape lighting*)

inner rooms 75-76, 79, 130, Appendix 12

lobbies 25, 30, 61, 76, 77, 80, 84, 85, 86, 87, 89, 90, 91, 95, 96, 97, 99, 100, 102, 103, 106, 109, Appendices 1, 7, 9, 10, 13

obstructions 55, 58, 59, 61, 126

roof exits 76, 80, 91-94, 101, 102, Appendix 1

signs and notices 30, 38, 52, 67, 94, 101-102

travel distance 25, 32, 66, 77, 78, 79, 81, 82, 84, 87, 89, 90, 91, 94, 95, 96, 97, 100, 108, 109, Appendices 1, 8, 9

Evacuation strategy 27, 28, 29, 30, 55, 85, 113, 116

External cladding 67, 111

External fire-spread 67, 111

Extinguishers 30, 43, 67, 104-105, 116, 117, 118, 121, 123

Extra care sheltered housing 107, 132

Extract systems 26, 32, 40, 64, 65, 73, 123, Appendices 7, 8, 9

F

Fire action notices 38, 116, 118, 119, 128, Appendix 5

Fire alarm systems 22, 28-29, 35, 38, 43, 44, 67, 72, 94, 103-104, 107, 108, 114, 115, 116, 117, 118, 119, 122, 123, Appendices 1, 2, 3, 6, 7, 8, 9, 10

tests and checks 123

Fire blankets 30, 105, 123

Fire dampers 74, 75, 124

Fire detection and alarm systems (*see fire alarm systems*)

Fire drills 118

Fire extinguisher (*see extinguishers*)

Fire-fighting lifts (*see lifts*)

Fire doors (*see doors, fire-resisting*)

Fire engineering 32, 76, 123, 131

Fire exit signs 30, 38, 67, 101, 102, 128

Fire load 59, 61

Fire mains 30, 91, 110, 116, 121, 125, 128, 132

Fire procedure notices (*see fire action notices*)

Fire procedures 112, 115, 118

Fire resisting doors (*see doors, fire-resisting*)

Fire risk assessment 21, 28, 29, 32, 34, 36, 39, 41-50, 52, 58, 59, 60, 65, 68, 69, 71, 73, 94, 104, 107, 109, 112, 113, 116, 118, 125, 126, 128, 131, Appendices 1, 2, 3, 7, 8, 9, 11, 12, 13

Fire safety audit 128, Appendix 2

Fire safety management 51, Part G 112-132

Fire Safety Order (*see Regulatory Reform (Fire Safety) Order 2005*)

Fire stopping 45, 73, Appendix 9, 13

Fire suppression systems 22, 72, 76, 81, 83, 94, 124, Appendix 12

Fire-fighting equipment and facilities

- access for fire-fighters (*see access for fire-fighters*)

- extinguishers (*see extinguishers*)

- fire-fighting lifts (*see lifts, fire-fighting*)

- fire mains (*see fire mains*)

FSO (*see Regulatory Reform (Fire Safety) Order 2005*)

G

Glazing, fire-resisting 26, 91, 100, 128 Appendix 1, 9, 11

H

Heating 26, 46, 51, 64-65, Appendix 2

High-rise blocks 18, 20-21, 67, 71, 111, 131, Appendices 1, 6

Hose reels 67, 104

Housing Act 2004 34, 36-37, 39, 40, 46, Appendix 13

Housekeeping 51, 55-61, 117, Appendix 2

I

Ignition sources 53, 55, 58, Part E 51-65

K

Kitchens 26, 40, 64, 73, 74, 76, 77, 78, 79, 96, 107, Appendices 1, 6, 8, 9, 12

L

Leases 37, 40, 46, 54, 105, 115, 125, 129, Appendices 6, 7, 9, 13

Leasehold flats 40, 46, 65, 75, 113, 125, Appendix 13

Lifts

evacuation 109

fire-fighting 110, 125, 130, 132, Appendix 2

Lightning 51, 65, Appendix 2

Linings (*see surface finishes*)

Low-rise blocks 20, 21, 49, 72, 102, 131

M

Maintenance 33, 34, 35, 37, 38, 40, 42, 43, 44, 46, 49, 51, 64, 65, 67, 69, 97, 110, 112, 113, 114, 115, 121, 122-126, 131, Appendices 2, 6, 7

emergency escape lighting 122-123

external fire escape routes 126

fire dampers 124

fire detection and warning systems 123-124

fire doors 125-126

fire extinguishers 123

fire-fighting lifts 125

fire mains 125

fire suppression systems 124

smoke control 124

Managed use (of common parts) 51, 58, 59-61, 62, 127

Means of escape 20, 22, 23-25, 35, 38, 44, 46, 74, 75-84, 85, 90, 94, 104, 106, 108, 109, 117, 123, Appendix 1

Mobility scooters 57, 59, 60, 61, 128

N

Non-destructive fire risk assessment 45, 46

O

OVs (openable vents) 86, 88, 89, 97, 123, 127

Overcladding (*see external cladding*)

P

People with special needs 21, 47, 59, 76, 109, 118, 120, 132, Appendices 1, 2, 3, 6

Personal emergency evacuation plans (PEEPs) 120

Portable appliance testing (PAT) 62, 63

Premises information box 120

Protected

Corridor 84, 87, 89, 103, Appendix 1

Lobby 84, 87, 89, 102, 103, 107, 109, Appendix 1

Stairway 30, 76, 85, 86, 103, 109, 110, Appendix 1

PVs (permanent vents) 86, 89, 129

R

Rainscreen cladding (*see external cladding*)

Record-keeping 39, 47, 112, 131

Refuge areas 109

Recycling 61-62

Regulatory Reform (Fire Safety) Order 2005 34, 37-39, 40, 41, 42, 43, 44, 45, 46, 47, 49, 50, 112, 113, 114, 115, 118, 128, 131, Appendices 2, 3

Relevant persons 38, 43

Risers 25, 26, 43, 45, 61, 64, 72, 84, 126, Appendices 8, 9

Rising mains (*see fire mains*)

Roof exits (*see escape roofs, roof exits*)

S

Security 51, 53, 54, 55, 61, 105-106

Sheltered housing 25, 29, 37, 56, 65, 67, 103, 105, 107-108, 118, 119, 120, 127, 131
extra care 107, 131

Shunt ducts 73, Appendix 1

Signs (*see fire exit signs*)

Signs and notices (*see fire ext signs*)

Simultaneous evacuation 28, 29, 85, 116, Appendix 5

Smoke

control 25, 29, 31, 32, 33, 35, 38, 62, 85-86, 87, 89, 94, 95, 96, 97, 98, 110, 123,
Appendices 1, 2, 7, 8, 9, 10, 13

detection (*See automatic fire detection systems*)

Smoke alarms 18, 19, 21, 22, 28-29, 32, 46, 67, 77, 103, 104, 108, 116, 124, Appendices 1, 2, 4, 6, 7, 8, 10, 11, 12, 13

Smoking 52-53, 128, Appendix 2

Sprinklers 32, 72, 76, 81, 83, 103, 124, Appendices 1, 2, 10

Staff training 50, 112, 117-118, 131, Appendix 2

Stairways

Escape (*see protected stairway*)

External 25, 76, 80, 84, 91, 102, 126-127, Appendix 1

Stay put

Policy 20, 22, 27-29, 40, 59, 67, 106, 107, 113, 115, 116, 118, Appendices 1, 3, 5, 6, 7, 8, 9, 10, 13

Storage 53, 57, 60, 61, 64, 71, 85, 102, 128, Appendix 2

Suppression systems 22, 72, 76, 81, 83, 94, 124, Appendix 12

Surface finishes 86, 111

T

Third-party certification 66, 71, 122, Appendices 3, 6

Timber frame 130

Travel distance (*see escape routes, travel distance*)

V

Ventilation

bathroom extract 26, 40, 64, 73, 74

kitchen extract 26, 40, 64, 73, 74

smoke control (*see smoke control*)

systems 40, 51, 64, 66, 73, 74

W

Water mist (*see also fire suppression system*) 32, 83, 124

Z

Zero tolerance 51, 58-59, 60



CFOA
Publications



**NATIONAL
HOUSING
FEDERATION**



Local Government Group

Local Government House
Smith Square
London SW1P 3HZ

Telephone 020 7664 3000

Fax 020 7664 3030

Email info@local.gov.uk

www.local.gov.uk

© Local Government Group, July 2011

For a copy in Braille, Welsh, larger print or audio, please contact us on 020 7664 3000. We consider requests on an individual basis.

L11-335